

**Baseline Surveys of Nearshore Fishes in and Near Central California
Marine Protected Areas 2007-2009**

Final Project Report Submitted to the Ocean Protection Council
22 April 2010

by

Richard M. Starr	University of California Sea Grant Extension Program
Dean Wendt	Center for Coast Marine Sciences, Cal Poly, San Luis Obispo
Katherine T. Schmidt	Moss Landing Marine Laboratories
Rosemary Romero	Moss Landing Marine Laboratories
Jahnava Duryea	Moss Landing Marine Laboratories
Erin Loury	Moss Landing Marine Laboratories
Noëlle Yochum	Oregon State University
Royden Nakamura	Center for Coast Marine Sciences, Cal Poly, San Luis Obispo
Leslie Longabach	Center for Coast Marine Sciences, Cal Poly, San Luis Obispo
Erin Nakada	Center for Coast Marine Sciences, Cal Poly, San Luis Obispo
Dave Rasmussen	Center for Coast Marine Sciences, Cal Poly, San Luis Obispo
Nate Hall	Center for Coast Marine Sciences, Cal Poly, San Luis Obispo
Kristen Green	Moss Landing Marine Laboratories
Selena McMillan	Moss Landing Marine Laboratories

with

Fishing Collaborators:

Dennis Baxter	F/V <i>New Captain Pete</i> ; Huck Finn Sportfishing, Half Moon Bay, CA
Alan Chin	F/V <i>Tigerfish</i> ; Tigerfish Sportfishing, South San Francisco, CA
Roger Cullen	F/V <i>Dorado</i> ; Morro Bay, CA
Tom Hafer	F/V <i>Kathryn H</i> ; Morro Bay, CA
Bob Ingles	F/V <i>Queen of Hearts</i> ; Houdini Sportfishing, Half Moon Bay, CA
Charlie Lanini	F/V <i>Admiral</i> ; Morro Bay, CA
Brad Leage	F/V <i>Princess</i> ; Morro Bay, CA
Darby Neal	Virg's Landing, Morro Bay, CA
Michele Leary	F/V <i>Rita G</i> ; Central Coast Sportfishing, Morro Bay, CA
Steve Moore	Patriot Sportfishing, Port San Luis, CA
David Lemon	F/V <i>Caroline</i> ; Chris' Fishing, Monterey, CA
Tom Mattusich	F/V <i>Huli Cat</i> ; Huli Cat Sport Fishing & Charter Boat, Half Moon Bay, CA
Giovanni Nevoloso	F/V <i>Gabbiano</i> ; Monterey, CA
Mike Ricketts	F/V <i>Sea Hawk</i> ; Monterey, CA
Sal Rocha	F/V <i>Patriot</i> ; Patriot Sportfishing, Avila Beach, CA
Dustin Selck	F/V <i>Pacific Horizon</i> ; Patriot Sportfishing, Port San Luis, CA
John Rowley	FV <i>Admiral</i> , Virg's Landing, Morro Bay, CA
Joe Kucera	FV <i>Patriot</i> , Patriot Sportfishing, Port San Luis, CA

Table of Contents

Abstract	2
Introduction	3
Results	4
Species Composition	
Hook-and-line Gear	4
Trap Gear	7
Catch Rate (CPUE) Analyses	
Hook-and-line Gear	9
Trap Gear	10
Biomass Analyses	
Hook-and-line Gear	11
Trap Gear	12
Length Analyses	
Mean Lengths	13
Hook-and-line Gear	14
Trap Gear	15
Comparisons of Length Frequencies with Lengths at Maturity	16
Hook-and-line Gear	16
Trap Gear	19
Skewness of Length-Frequency Distributions	20
Hook-and-line Gear	20
Trap Gear	20
Tag Recaptures	21
Acknowledgements	23
References	24
Appendix 1	28
Tables	33
Figures	84

Abstract

The California Collaborative Fisheries Research Program, a partnership of fishermen, non-governmental organizations, and agency and academic scientists, developed protocols for monitoring marine protected areas in central California using hook-and-line and trap fishing gear. In the summer and fall of 2007, 2008, and 2009 the protocols were used to collect information about species composition, catch rates, and sizes of nearshore fishes in the Año Nuevo, Point Lobos, Piedras Blancas, and Point Buchon State Marine Reserves, and corresponding co-located reference sites. A total of 115 surveys, employing hook-and-line methods, were conducted from 2007 – 2009; 47 in the fall of 2007, 48 in the summer and fall of 2008, and 24 in the summer and fall of 2009, in and near the Año Nuevo, Point Lobos, Piedras Blancas and Point Buchon marine protected areas. A total of 68 trap fishing surveys occurred in and near the Año Nuevo, Point Lobos, Cambria, and Piedras Blancas marine protected areas; 43 in 2008 and 25 in 2009. During these surveys, all caught fishes were identified, measured, tagged with external T-bar anchor tags, and released at location of capture. A total of 12 Commercial Passenger Fishing Vessels, 4 commercial trap-fishing vessels, and 415 volunteer anglers spent a total of 1,121 hours fishing with hook-and-line gear, and 3,445 hours fishing with trap gear. This combined effort resulted in a total catch of 26,262 fishes, which were comprised of 42 species. Of the total catch 22,551 fishes were tagged and released. Out of the fishes released with tags, 119 were recaptured and reported to our offices with information about the location of recapture. The ten most frequently caught species were similar among marine protected areas, and the composition between paired marine protected areas and reference sites is more similar than among marine protected areas, indicating that the reference sites chosen are well-suited for comparisons with associated marine protected areas. Catch and biomass rates for most species were higher in marine protected areas than in reference sites, indicating habitat differences existed prior to the establishment of the MPAs. When differences in mean lengths of fishes were detected, the lengths were most often greater in marine protected areas than in associated reference sites.

Keywords: Nearshore fishes, Marine Protected Areas, tag-recapture, baseline data collection and/or analysis, CPUE, catch composition, biomass evaluation, length analyses, maturity comparisons.

Introduction

On September 21, 2007, 29 Marine Protected Areas (MPAs) were established along the central California coast from Pigeon Point to Point Conception. (Figure 1, Figure 2). The 1999 Marine Life Protection Act that led to the formation of the new MPAs specifically required California MPAs to be monitored and evaluated (Weber 2000). In preparation for this requirement, in the winter and spring of 2007 we conducted a series of five workshops with fisheries scientists and the fishing communities of Half Moon Bay, Monterey, Morro Bay, and Port San Luis, California to develop protocols for monitoring MPAs using hook-and-line fishing gear. In the summers and falls of 2007, 2008, and 2009 we used the protocols developed at the workshops to collect information about species composition, catch rates, and sizes of nearshore fishes in the Año Nuevo, Point Lobos, Piedras Blancas, and Point Buchon State Marine Reserves (MPAs), and corresponding reference (REF) sites (Figure 3). In 2008, we conducted additional workshops with members of the live-fish fishery to develop protocols for monitoring MPAs using trap fishing gear. Trap fishing protocols were used in 2008 to assess the Año Nuevo, Point Lobos, Piedras Blancas, and Cambria MPAs and REF sites. In 2009, trap sampling occurred in the Point Lobos, Piedras Blancas, and Cambria MPAs (Figure 4). Specific sampling protocols and terminologies are described in Appendix 1.

Using hook-and-line survey methods, we completed 47 surveys in the fall of 2007, 48 surveys in the summer and fall of 2008, and 24 fishing trips in the summer and fall of 2009 in the Año Nuevo, Point Lobos, Piedras Blancas and Point Buchon MPA and REF sites, for a total of 115 hook-and-line fishing surveys from 2007 – 2009 (Table 1). Using trap survey techniques, we completed 43 fishing trips in 2008 and 25 trips in 2009, for a total of 68 sampling trips from 2008 – 2009 in the Año Nuevo, Point Lobos, Cambria, and Piedras Blancas MPA and REF sites (Table 1). During these surveys, all caught fishes were identified, measured, tagged with external T-bar anchor tags with individual identification numbers (if deemed able to sustain handling and tagging), and released at location of capture. To date we have worked with a total of 12 Commercial Passenger Fishing Vessels (CPFVs), 4 commercial trap-fishing vessels, and 415 volunteer anglers, who spent a total of 1,121 hours hook-and-line fishing, and 3,445 hours trapping. This combined effort resulted in a total catch of 26,262 fishes comprised of 42 species, and a total of 22,551 fishes released with tags. In this report 26,087 fishes are used in the analyses because some were captured outside designated sampling locations (grid cells). Of these 26,087 fishes, 22,305 were captured with hook-and-line and 3,782 were captured with trap gear (Table 1). After each field sampling season, we held workshops in Morro Bay, Moss Landing, and Half Moon Bay to describe the results of the fieldwork, encourage project feedback, and receive suggestions from the fishing community. Each year, a total of about 40 people from the fishing community reviewed the data at these meetings.

The purpose of the work we conducted was to provide a baseline characterization of the newly enacted MPAs. In order to facilitate future evaluations of MPAs, we have organized the analyses of the data presented in this report according to the types of questions that will be asked to determine how fish populations in MPAs might change over time. The types of questions that will need to be asked to determine how populations in MPAs have changed relative to REF sites include:

1. What are the current similarities and differences in species composition among areas in central CA and between individual Marine Protected Areas (MPAs) and their co-located reference (REF) sites?

2. What are the differences in catch rates of species among areas in central CA and between individual Marine Protected Areas (MPAs) and their co-located reference (REF) sites?
3. What are the differences in biomass of species among areas in central CA and between individual Marine Protected Areas (MPAs) and their co-located reference (REF) sites?
4. What are the differences in length composition among areas in central CA and between individual Marine Protected Areas (MPAs) and their co-located reference (REF) sites?
5. What is the likelihood of adult spillover of different species inhabiting MPAs?

Results

1) What are the current similarities and differences in species composition among areas in central CA and between individual Marine Protected Areas (MPAs) and their co-located reference (REF) sites?

Species Composition from Hook-and-line Gear

We caught and identified a total of 22,275 fishes, comprising 36 species and two family groups, from all four study areas from 2007 – 2009. In all areas, rockfishes were the predominant species group, comprising 96% of the total catch. For all areas combined (Table 2), the most abundant rockfishes, in terms of percentage of overall catches, were blue rockfish (34%), gopher rockfish (31%), black rockfish (11%), and olive rockfish (8%). There were 16 species common to the catch in all four areas: black, black and yellow, blue, canary, china, copper, gopher, kelp, olive, rosy, vermilion and yellowtail rockfishes, and cabezon, kelp greenling, lingcod, and mackerel (Table 3).

The relative abundance of each species differed among geographic areas and three or four species comprised the dominant catch at each area (Figure 5). Black, blue, gopher, and olive rockfishes combined to provide more than 66% of the catches in each area. Whereas blue rockfish were prevalent in all areas, they represented the largest percentage of the catch in Point Lobos (46%). Gopher rockfish were also prevalent in all areas, but represented the largest percentage of the catch in Point Buchon (50%). Black rockfish were a prominent part of the catch (35%) only in Año Nuevo. Olive rockfish were most abundant at Point Lobos (14%) and Piedras Blancas (12%). Species-specific catch information regarding area, site, and gear type for the ten most frequently caught species is listed in Table 4.

Año Nuevo

A total of 26 species, including 14 rockfish species, was caught in the Año Nuevo area (Table 5). The catch consisted primarily of black rockfish (35%), blue rockfish (33%), and gopher rockfish (18%). A total of 22 species (including 14 rockfishes) was caught in the MPA, whereas a total of 23 species (including 13 rockfishes) was caught in the REF site (Table 5). The most frequently caught species in the MPA were blue rockfish (33%), black rockfish (27%), and gopher rockfish (24%). Similarly, the most frequently caught species in the REF site were black rockfish (41%), blue rockfish (33%), and gopher rockfish (13%).

The 12 species that were caught at both sites in all years included black, blue, brown, canary, china, gopher, olive, vermilion and yellowtail rockfishes, in addition to cabezon, kelp greenling, and lingcod. Overall species richness was greatest (19 species) in the REF site in

2008, and in the MPA in 2009 (Figure 6A). The most rockfish species caught in a given site in a single year (14 species) was in 2009 in the MPA.

Point Lobos

A total of 23 species, including 16 rockfish species, was caught in the Point Lobos study area (Table 6). The catch consisted primarily of blue rockfish (46%), gopher rockfish (24%), and olive rockfish (14%). A total of 21 species (including 14 rockfish species) was caught in the MPA, whereas a total of 21 species (including 16 rockfish species) was caught in the REF site (Table 6). The most frequently caught species in the MPA were blue rockfish (50%), gopher rockfish (21%), and olive rockfish (16%). The most frequently caught species in the REF site were also blue rockfish (39%), gopher rockfish (31%), and olive rockfish (9%).

The 12 species that were caught at both sites in all years included black, blue, canary, china, copper, gopher, kelp, olive, rosy, vermilion, and yellowtail rockfishes, as well as lingcod. Overall species richness was greatest (19 species) in the MPA site in 2007 (Figure 6B). The most rockfish species caught in a given site in a single year (15 species) occurred in 2008 in the REF site.

Piedras Blancas

Of all the areas sampled, species richness (29 species, including 17 rockfishes) was greatest at Piedras Blancas (Table 7). The catch consisted primarily of gopher rockfish (36%), blue rockfish (23%), olive rockfish (12%), and vermilion rockfish (11%). A total of 22 species (including 17 rockfishes) was caught in the MPA, and a total of 25 species (including 15 rockfishes) was caught in the REF site (Table 7). The most frequently caught species in the MPA were gopher rockfish (30%), blue rockfish (24%), olive rockfish (18%), and vermilion rockfish (11%). The most frequently caught species in the REF site were gopher rockfish (43%), blue rockfish (22%), and vermilion rockfish (10%).

At Piedras Blancas, 16 species were caught at both the MPA and REF sites: black, blue, brown, canary, copper, gopher, kelp, olive, rosy, starry, treefish, vermilion, and yellowtail rockfish, as well as kelp greenling, lingcod and sanddab. Species richness (21 species) was greatest in the MPA and REF site in 2008 (Figure 6C). The most rockfish species caught in a given site in a single year (16 species) was in 2008 in the MPA.

Point Buchon

A total of 25 species (including 15 rockfish species) was caught in the Point Buchon area (Table 8). The catch consisted primarily of gopher rockfish (50%), blue rockfish (21%), and black rockfish (10%). A total of 22 species (including 15 rockfish species) was caught in the MPA, and a total of 23 species (including 15 rockfish species) was caught in the REF site (Table 8). The most frequently caught species in the MPA were gopher rockfish (48%), blue rockfish (25%) and black rockfish (8%). The most frequently caught species in the REF site were also gopher rockfish (52%), blue rockfish (16%) and black rockfish (12%).

The 12 species that were caught at both sites in all years included black, black and yellow, blue, copper, gopher, rosy, starry, treefish, vermilion, and yellowtail rockfishes, as well as cabezon and lingcod. Species richness (20 species) was greatest in both the MPA and REF site in

2008 (Figure 6D). The most rockfish species caught in a given site (15 species) was in the MPA in 2007 and in the REF site in 2008.

Comparison of Species Composition Between MPA and Associated REF Sites

Our understanding of the rock lithology and associated habitats (Norris & Webb 1990, Wagner et al. 2002, Kvitek 2010) in each of the areas we studied would lead us to expect that species composition would be more similar between a given MPA and REF pair than among MPAs. To test this, we conducted multivariate comparison analyses to compare species composition among areas and between MPA and REF sites. We did this by comparing the relative species compositions (i.e., percentages of the total catch) between sites in each area for each year. A square-root transformation of the relative species composition in each area was applied to moderately down-weight the contribution of the most abundant species. We then used a Multi-Dimensional Scaling (MDS) plot based on the Bray-Curtis similarity matrix to graphically assess similarity in species composition among areas, sites and years (Quinn & Keough 2002). In an MDS plot, the distance between samples on the map agrees with the rank order of the same similarity taken from the matrix. The MDS plot (Figure 7) revealed that similarities in species composition were greatly influenced by geographic area, which is reflected in the four relatively distinct clusters of points on the plot.

In addition to the graphical analysis, we compared differences in species composition among areas with a permutation MANOVA (formerly called “nonparametric MANOVA”), using the “Vegan” package in the “R” statistical program (Oksanen 2010). Redundancy analysis is based on permutation tests and is unaffected by non-normal data, which are characteristic of species abundance matrices with many zeroes. Data were tested for homogeneity of multivariate dispersions using the “betadisper” function in the “R” statistical package, and were found to satisfy the assumption of equal variances. Percent similarity in species composition was calculated between MPA and REF sites at each area, and between each pair-wise combination of MPAs using the following index (Renkonen 1938):

$$P = \sum_i \min(p_{1i}, p_{2i})$$

where P = Percentage similarity between sample 1 and 2

p_{1i} = Percentage of species i in community sample 1

p_{2i} = Percentage of species i in community sample 2.

The results of our spatial analyses indicate that species composition between paired MPAs and REF sites (values along diagonal in Table 9) is more similar than among MPAs in different areas (Table 9). We expected the REF sites to be very similar to the MPAs because we used habitat maps and the knowledge of experienced fishermen to select the areas for references. Although the similarities between MPAs in different areas were at least 58%, the differences among areas were significant (permutation MANOVA, $F = 13.19$, $p = 0.0001$). The importance of this finding is that the diversity of rock types and habitats along the central California coast indicates that MPAs are not true replicates of one another, but the MPAs and co-located REF sites can be treated in pair-wise comparisons because of their similarities.

The results of our temporal analyses indicate that species composition varied among years (Tables 5-8). Species composition in 2009 differed from species composition in 2007 and 2008 in all areas except Año Nuevo. However, great similarity between years at a single site occurred

in the Point Lobos MPA between 2007 and 2008, in the Point Lobos REF site between 2007 and 2008, and in the Año Nuevo REF site between 2008 and 2009.

Examining the Bray-Curtis MDS scaling plot spread (Figure 7), at Año Nuevo, there were differences in species composition between MPA and REF sites in all years. With the exception of REF site in 2008 and REF site in 2009, species composition also varied between each site from year to year. At Point Lobos and Point Buchon, species composition was different between the MPA and REF sites in every year. Species composition was similar between years in the MPA site in 2007 and 2008 and in the REF site in 2007 and 2008. In Piedras Blancas, data were only available for 2008 and 2009. Species compositions were dissimilar between the MPA and REF sites in 2008, and differences in species composition increased in 2009, reflecting the greatest difference in composition between sites out of all four areas.

Effects of Different Types of Hook-and-line Gear on Species Composition

Anglers fished an equal amount of time with each gear type: lingcod bars (BAR), unbaited shrimp flies (FLY), or shrimp flies baited with squid (BAIT). Each gear type caught approximately one-third of the total catch; however, different gear types targeted different species (Table 10). The BAR catch was comprised primarily of blue rockfish (32%), gopher rockfish (25%), and olive rockfish (13%). The FLY catch was comprised primarily of blue rockfish (38%), gopher rockfish (26%), and black rockfish (14%). The BAIT catch was comprised primarily of gopher rockfish (40%), blue rockfish (31%), and black rockfish (10%). Species richness was greater for BAR (36 species) than FLY and BAIT (28 species), presumably because BAR gear consisted of both a lingcod bar and a shrimp fly teaser, thus targeting a greater variety of species. However, the number of rockfish species caught was nearly equal among all gear types.

Species-specific differences did appear in each area in catch by gear-type (Table 11). BAR gear caught the greatest number of lingcod, whereas gopher rockfish were caught most often using BAIT. These data underscore the importance of using a variety of gear so that the catches integrate differences in selectivity of gear types, thus providing a clearer view of the nearshore fish assemblages.

Species Composition from Trap Gear

Species composition was analyzed for 3,782 fishes caught between 2008 and 2009. A total of 18 different species was caught by trap gear (Table 12). Nine of these species were rockfishes, which comprised 75% of the catch. Out of 18 total species, 7 species (black-and-yellow rockfish, cabezon, gopher rockfish, grass rockfish, kelp greenling, lingcod, and wolf eel) were caught in all four areas. The predominant species caught for all areas surveyed were gopher rockfish (55%), black-and-yellow rockfish (18%), cabezon (14%), and kelp greenling (8%).

Año Nuevo

Año Nuevo was only surveyed using trap gear in 2008. Nine species, including four rockfish species, were caught in the Año Nuevo study area (Table 12). The catch consisted primarily of cabezon (31%), gopher rockfish (27%), kelp greenling (17%) and black-and-yellow rockfish (15%). Species composition was similar between the MPA and REF site at Año Nuevo (Table 13, Figure 8A). A total of eight species (including three rockfish species) was caught in

the MPA, and a total of seven species (including four rockfish species) was caught in the REF site. The most frequently caught species in the MPA were gopher rockfish (39%), cabezon (20%), kelp greenling (15%) and black-and-yellow rockfish (13%). The most frequently caught species in the REF site were cabezon (47%), kelp greenling (21%), and black-and-yellow rockfish (16%).

Point Lobos

A total of 15 species (including eight rockfish species) was caught in the Point Lobos study area (Table 12). The catch consisted primarily of gopher rockfish (58%), black-and-yellow rockfish (14%), kelp greenling (11%) and cabezon (11%). A total of 13 species (including eight rockfish species) was caught in the MPA, and 13 species (including seven rockfish species) were caught in the REF site for all years (Table 13, Figure 8B). Species composition was similar between MPA and REF sites in all years. The most frequently caught species at both sites included black-and-yellow, gopher, and treefish rockfishes, as well as cabezon, kelp greenling and lingcod. Species richness (12 species) was greatest in both the MPA and REF in 2008.

Piedras Blancas

A total of 14 species (including eight rockfish species) was caught in the Piedras Blancas study area (Table 12). The catch consisted primarily of gopher rockfish (47%), black-and-yellow rockfish (19%), and cabezon (19%). A total of eight species (including four rockfishes) was caught in the MPA, and a total of 12 species (including seven rockfishes) was caught in the REF site (Table 13, Figure 8C). The most frequently caught species at both sites were black-and-yellow rockfish, cabezon, gopher rockfish, kelp greenling, kelp rockfish, and lingcod. Species richness (12 species) was greatest in the REF site in 2008. The most rockfish species (seven species) was also caught at the REF in 2008.

Cambria

A total of 13 species (including seven rockfishes) was caught in the Cambria study area (Table 12). The catch consisted primarily of gopher rockfish (59%), black-and-yellow rockfish (20%) and cabezon (13%). A total of 10 species (including 5 rockfish species) was caught in the MPA, and a total of 11 species (including seven rockfishes) was caught in the REF site (Table 13, Figure 8D). The most abundant species, in terms of percentage of catch, in the MPA were gopher rockfish (58%), black-and-yellow rockfish (18%), and cabezon (15%). The most frequently caught species in both sites in both years included black-and-yellow and gopher rockfishes, as well as cabezon, kelp greenling, and lingcod. Species richness (nine species) was greatest in the MPA and REF site in 2008, as well as in the REF site in 2009.

Invertebrates Caught in Traps

During trap gear surveys in 2008, a total of 2,607 individual mobile invertebrates were caught from the Año Nuevo, Point Lobos, Cambria, and Piedras Blancas study areas and identified to genus or species (Table 14). In 2009, a total of 1,541 invertebrates were caught and identified in the Point Lobos, Cambria, and Piedras Blancas study areas (Table 14). Overall, a total of 19 invertebrate taxa were sampled in both years; catches were dominated by sea stars and crabs.

2) What are the differences in catch rates of species among areas in central CA and between individual Marine Protected Areas (MPAs) and their co-located reference (REF) sites?

A one-way ANOVA was used to test for differences in catch rates between sites (MPA and REF) and among years (2007 – 2009). The assumptions of normality were evaluated by examining residuals, and variances were tested using a Levene's test of variance homogeneity. When appropriate, data were transformed to meet the assumptions of the analyses. Planned pairwise comparisons among years were tested using Fisher's least significant difference method. Only the most frequently caught species at each area that conformed to the assumptions of the analyses are presented here.

Catch rates (CPUE) from Hook-and-line Gear

Catch rates (CPUE) from the hook-and-line gear study are reported as the annual average catch per angler hour and were calculated by dividing the total fishes caught by total angler hours in a sampling cell in a day and averaging the resulting values for a year (see Appendix 1). The highest annual catch rate was 19.7 ± 2.5 (SE) fish per angler hour in the Point Lobos MPA in 2007, and the lowest was 3.1 ± 0.05 (SE) fish per angler hour in the Point Lobos REF site in 2009 (Table 15). Within each site, catch rates varied by species (Table 16). The highest catch rates were consistently obtained for black, blue, and gopher rockfishes (Figure 9). Significant differences in catch rates between sites were observed for several of the ten most frequently caught species in all four areas, based on a two-way ANOVA.

Comparison of Catch Rates in MPA and REF Sites

For the most part, greater catch rates were observed in MPAs than in REF sites (Figure 9). Because our study started the year that most MPAs were established, these differences in catch rates are primarily due to habitat differences and not to MPA effects (with the exception of the Point Lobos MPA, which has been protected since 1973). In the Año Nuevo area, black, blue, and china rockfishes were larger in the REF site, whereas gopher rockfishes were caught at significantly higher rates in the MPA at Año Nuevo (ANOVA, $p < 0.001$, Figure 10). Significant differences in blue rockfish catch between sites at the Año Nuevo area were only observed in 2007 ($p < 0.05$; Figure 10). In the Point Lobos area, blue, gopher and olive rockfishes were caught at significantly greater rates in the MPA site than in the REF site ($p < 0.001$, Figure 11), and catch rates of china, copper, kelp, lingcod, and vermilion rockfishes were all greater in the MPA. In the Piedras Blancas area, blue rockfishes were caught at significantly greater rates in the MPA than the REF site ($p < 0.05$; Figure 12), and china, copper, olive and vermilion rockfishes were also caught at higher rates. In the Point Buchon area, blue rockfish were caught at significantly greater rates ($p < 0.05$) in the MPA than the REF site in 2007 and 2008 but no difference was observed between sites for 2009 catch rates (Figure 13). Gopher rockfishes also were caught at significantly ($p < 0.001$) greater rates in the Point Buchon MPA than the REF site.

Annual variability in Catch Rates

Annual differences in catch rates were dependent on area and species of fish (Figure 9). At Año Nuevo, gopher rockfish catch rates in 2007 were significantly less than in 2008 and 2009 (Figure 10). No differences were observed between 2008 and 2009 gopher rockfish catch rates.

For the Point Lobos area, blue rockfish catch rates were significantly less in 2009 than in both 2007 and 2008 (Figure 11). No differences in blue rockfish catch rates were observed between 2007 and 2008. Gopher rockfish catch rates at Point Lobos were significantly greater in 2007 than in 2008 and 2009. No differences were observed in gopher rockfish catch rates between 2008 and 2009. In the Piedras Blancas area, blue and copper rockfishes were caught at significantly ($p < 0.05$ and $p < 0.001$, respectively) greater rates in 2008 than 2009 (Figure 12). For the Point Buchon area both blue and gopher rockfishes were caught at lower rates ($p < 0.001$) in 2009 than in 2007 and 2008 (Figure 13).

Sampling Effort Needed to Reduce Coefficient of Variation of Catch Rates

We evaluated the coefficient of variation of catch rates with regard to the number of sampling days to determine the number of days needed to minimize variability in mean CPUE without over-sampling. The mean catch per angler hour per day of all species caught using hook-and-line gear was used to generate CPUE values for a range of hypothetical sampling periods (1 to 20 days) using re-sampling statistics (Resampling Stats 6.0). The resulting CPUE data were aggregated into bins by day and averaged over 50,000 iterations for each of the four MPAs fished in this study. Mean CPUE and coefficient of variance (CV) were calculated for each hypothetical sampling period (Figure 14), and provided an estimate of the number of sampling days necessary to yield CV values ≤ 0.5 or ≤ 0.25 (Table 17). We found that sampling for two days per year yields a CV ≤ 0.5 for 40% of the 10 most frequently caught species in all four areas, and increasing sampling effort to three days per year provides a CV of ≤ 0.5 for more than half of the abundant species in all four areas (Table 17). To reduce the CV to ≤ 0.25 , six to nine days of sampling per year is necessary for abundant species and 15 days or more for the species less frequently caught.

Catch rates (CPUE) from Trap Gear

Catch rates from the trap study are reported as the annual average catch per trap hour. These CPUE values were calculated by dividing the total fishes caught by the total trap hours fished in a cell in a day (total soak time) and averaging the resulting values for a year (see Appendix 1). The highest annual average catch rate was 2.0 ± 0.3 (SE) fish per trap hour occurred in the Point Lobos MPA in 2008 and the lowest catch rate occurred in 2008 in the Año Nuevo REF site (0.2 ± 0.1 fish per trap hour, Table 18). Within each site, catch rates also varied by species (Table 19). The greatest overall catch per trap hour values were for black-and-yellow rockfish, cabezon, and gopher rockfish (Figure 15).

Comparison of Catch Rates in MPA and REF Sites

In each of the four areas, about half of the most abundant species were caught at greater rates in the MPA than in the REF sites (Figure 16), however ANOVA analyses indicated that greater trap catch rates were usually not significantly ($p > 0.05$) different between sites. For most areas, catch rates for all species were similar between MPA and REF sites (Table 19). In the Point Lobos area, however, gopher rockfishes were caught at significantly greater rates ($p < 0.05$) in the MPA than in the REF site in 2008 but not in 2009. Kelp greenling in the Point Lobos area were caught at significantly greater rates in the REF site ($p < 0.05$) than in the MPA in 2008 whereas no differences were observed between sites in 2009.

Sampling Effort Needed to Reduce Coefficient of Variation of Catch Rates

Mean catch per hour per day of all species caught using trap gear for all years was used to generate CPUE values for a range of sampling periods (1 to 20 days) using re-sampling statistics. Catch per trap hour per day values for the trap study are the sum of data from all traps set in one day (10-61 traps/day). Each hypothetical sampling period (1–20 days) was sampled at 50,000 iterations for each of the four MPAs fished in this study (Año Nuevo, Point Lobos, Piedras Blancas, and Cambria). The resulting CPUE data were aggregated into bins by day and averaged over 50,000 iterations for each of the four MPAs fished in this study. Mean CPUE and coefficient of variance (CV) were calculated for each hypothetical sampling period (Figure 17), and provided an estimate of the number of sampling days necessary to yield CV values ≤ 0.5 or ≤ 0.25 (Table 20). To generate a CV of ≤ 0.5 for three of the seven most frequently caught species in all four areas, it is necessary to sample for at least four days. To generate a CV of ≤ 0.25 for most species in all four areas, sampling for 15 days would be necessary (Table 20).

3) What are the differences in biomass of species among areas in central CA and between individual Marine Protected Areas (MPAs) and their co-located reference (REF) sites?

A one-way ANOVA was used to test for differences in biomass caught between MPA and REF sites and among years for the duration of the study. Differences in biomass caught among months sampled were not tested due to limited replication of months across all years of study. Biomass analyses are restricted to the top 10 (hook-and-line gear) or top seven (trap gear) most frequently caught species. Fish biomass was calculated from fish lengths using the length-weight relationship: $W = aL^b$, where W = weight in grams and L = length in mm. Species-specific constants (a and b) were derived from Lee et al. (1999) and Colton & Larson (2007). Biomass values were then standardized for effort (BPUE) depending on sampling method (hook-and-line or trap gear) and reported as kg/hr. The assumptions of normality were evaluated by examining residuals, and variances were tested using a Levene's test of variance homogeneity. When appropriate, data were transformed to meet the assumptions of the analyses. Planned pairwise comparisons among years were tested using Fisher's least significant difference method.

Biomass Analyses Hook-and-line Gear

Biomass values from the hook-and-line study are reported as the annual average biomass per angler hour. These BPUE values were calculated by dividing the total fish biomass caught by total angler hours in a cell in a day and then averaging the values for the year. The greatest biomass caught per angler hour was in the Point Lobos MPA in 2007 (10.0 ± 1.4 average kg per angler hour) and the least was in the Point Lobos and Point Buchon REF sites in 2009 (1.5 ± 0.2 average kg per angler hour, Table 21). Within each site, biomass caught also varied by species. Greatest biomass values were observed for black, blue, gopher, and olive rockfishes in all areas combined (Table 22). Significant differences in biomass of fishes caught between sites were observed for several of the ten most frequently caught species in all four areas using a two-way ANOVA.

Comparisons of Biomass between MPA and REF Sites

Biomass of catches was generally greater in MPA sites when compared to reference sites (Figure 18, Figure 19). In all three years, the biomass of 70–90% of the most frequently caught species using hook-and-line gear was larger in the MPA than the REF site. In the Año Nuevo

area, significantly greater biomass of black rockfish was caught ($p < 0.05$; Figure 18) in the REF site than in the MPA while the opposite was true for gopher rockfish ($p < 0.05$; Figure 18). Differences in blue rockfish biomass caught between sites at the Año Nuevo area were only observed in 2008 ($p < 0.05$; Figure 18). In the Point Lobos area, no significant differences were observed in gopher rockfish biomass caught (Figure 18) between the two sites. In the Piedras Blancas area, a significantly greater biomass of copper, olive, and vermilion rockfishes was caught in the MPA than the REF site ($p < 0.05$, $p < 0.001$, and $p < 0.05$, respectively; Figure 18), whereas no difference in biomass caught between sites was observed for gopher rockfishes and lingcod. In the Point Buchon area, significantly greater biomass of blue rockfish was caught in the MPA site than the REF site in 2007 and 2008, whereas no difference was observed in 2009 (Figure 18). Significantly greater amount of gopher rockfish biomass was caught in the MPA than the REF site in Point Buchon ($p < 0.05$; Figure 18).

Annual variability in Biomass Estimates

Inter-annual differences in biomass caught in the Año Nuevo area were only observed for gopher rockfish (Figure 19). Biomass of gopher rockfish caught was greater in 2008 and 2009 than in 2007. No differences were observed between gopher rockfish biomass caught in 2008 and 2009. For the Point Lobos area, biomass of gopher rockfish was greater in 2007 than in 2008 (Figure 19). No differences in gopher rockfish biomass were observed between 2007 and 2009, or 2008 and 2009. In the Piedras Blancas area, biomass of copper rockfish was greater in 2009 than 2008 ($p < 0.05$; Figure 19). For the Point Buchon area, annual variability of blue rockfish biomass was dependent on site. Overall, as with the catch rate analyses, 2009 tended to stand out as different from 2007 and 2008 (Figure 19).

Biomass Analyses Trap Gear

Biomass per unit effort (BPUE) from the trap study are derived from length data as discussed earlier in the hook-and-line section, but are standardized for effort using the average biomass of fish caught per trap hour. Total fish biomass caught was divided by the total trap hours fished in a cell in a day. Total trap hours are the sum of all trap soak times per cell per day. The greatest biomass caught per trap hour was observed in the Point Lobos MPA (1.0 ± 0.1 average kg per trap hour) and the least was in the Año Nuevo area (0.4 ± 0.1 average kg per trap hour, Table 23). Within each site, biomass caught also varied by species (Table 24, Figure 20). The greatest overall BPUE values were for black-and-yellow rockfish, cabezon, gopher rockfish, and lingcod. Significant differences in biomass between sites were observed for several of the seven most frequently caught species in all four areas, based on a two-way ANOVA (Figure 20).

Comparisons of Biomass between MPA and REF Sites

In all four areas, about half of the seven most frequently caught species were caught in greater biomass in the MPA than in the REF site. In both years fished using trap gear, at least 43% of the most frequently caught species were caught in greater biomass in the MPA than the REF site and 29% of these species were caught in equal biomass across sites (Figures 20, 21). Significant differences in biomass between sites were species dependent. In the Año Nuevo area, no significant differences in biomass were observed between the MPA and the REF site for black-and-yellow rockfish, cabezon, or kelp greenling (Figure 20). In the Point Lobos area, no significant differences ($p > 0.05$) in biomass were observed between the MPA and REF site for black-and-yellow rockfish and cabezon. However, kelp greenling biomass was significantly

greater ($p < 0.05$) in the MPA than the REF site in 2009 but not in 2008 in Point Lobos. In the Piedras Blancas area, there were no significant ($p > 0.05$) between-site differences in biomass for black-and-yellow gopher rockfishes or kelp greenling (Figure 20). Cabezon biomass, however, was significantly greater in the REF site than the MPA in both 2008 and 2009 for Piedras Blancas ($p < 0.05$). In the Cambria area, no significant differences were observed in biomass caught between sites for cabezon (Figure 20).

Annual Variability in Biomass Estimates

In general, the only differences in biomass observed between the two years sampled were in the Point Lobos area. Year was not included as a factor in the analysis of biomass caught in the Año Nuevo area, as this area was only sampled in 2008 using traps. For the Point Lobos area, no differences in black-and-yellow rockfish or cabezon biomass caught were observed between 2008 and 2009 (Figure 21). Annual variability in kelp greenling biomass caught in the Point Lobos area was dependent upon site; see section above for details. No significant ($p > 0.05$) annual differences in black-and-yellow, gopher, and grass rockfishes, or cabezon and kelp greenling biomass caught in the Piedras Blancas area were observed. For the Cambria area, no significant annual differences were observed in cabezon biomass caught. The ability to discuss inter-annual trends, however, is restricted by the few number of years in which the areas were sampled using the trap gear.

4) What are the differences in length composition among areas in central CA and between individual Marine Protected Areas (MPAs) and their co-located reference (REF) sites?

Mean Lengths

Mean lengths are used as indicators of fished species population status as they are 1) relatively quick and inexpensive to obtain with minimal error involved, 2) are available further back in historical records which allows for comparisons over longer periods of time, and 3) can be inferred from catch records in certain cases. Historically in un-fished rockfish populations, a large proportion consisted of older, larger, and more fecund individuals. At the inception of the fisheries, catches were comprised of these larger fish, thus the mean length of the catch for a species was larger than at later dates. A decline in mean length of a species in a mature fishery is often considered an indicator of increased fishing mortality and that the population is becoming stressed.

There are several reasons why mean lengths of catches can decline in unstressed populations. First, if a strong year-class is successful in recruiting to the population, one would expect the catches to be dominated by small fish at first, reducing the mean length, and then as that year-class grows, mean lengths would increase as that cohort ages. When recruitment and growth remain the same over the years, the mean lengths decrease and do not rebound, until fishing mortality lessened (Mason 1998).

Considering the short time span of our study, increases of mean lengths from the beginning of the monitoring in 2007 to 2009 could indicate that the population of an area is getting older and growing larger, with minimal recruitment of small fish, and likely does not represent an immigration of fish from an outside area. Decreases of mean lengths over the 2007-2009 time-span could indicate that 1) smaller fish are recruiting to the local population, thus lowering the average length and/or 2) the larger fish of the population are being removed and/or were not

caught as often as smaller fish. In MPA areas where fishing is restricted; a decreasing in mean length of a species population in the area is likely indicative of a recruitment pulse. Similarities and differences in mean length between MPAs and co-located REF sites can provide insight into the many factors causing average lengths to change. For example, if mean lengths of populations are decreasing both inside and outside MPAs, then it is likely that a recruitment event is taking place. Alternatively, if mean length decreases only outside an MPA then it is likely that fishing is selectively removing larger individuals from the population at a rate that is not compensated by growth.

Hook-and-line Gear

The total length of each fish captured in the study was measured to the nearest centimeter. For each species, we first aggregated and then averaged lengths of all fishes caught during the entire study period to evaluate differences between MPA and REF sites in each of the study areas. We then plotted mean lengths of the ten most frequently caught species (Figure 22). To evaluate interannual differences in mean lengths, we plotted the mean lengths of the ten most frequently caught species for each year of the study (Figure 23). We then evaluated differences in mean lengths using ANOVAs. Assumptions of ANOVAs (normality, equal variances, and no interaction between the two factors of site and year) were tested, and in some cases data were transformed to meet assumptions. Only ANOVA results from species that met all assumptions are reported with p-values.

Across all areas surveyed, mean lengths of black rockfish, copper rockfish, lingcod, olive rockfish, vermilion rockfish, and yellowtail rockfish were typically greater in MPA sites than REF sites; whereas mean lengths of gopher rockfish were typically greater in REF sites. This is probably due to differences in habitats among sites. Mean lengths of all species were influenced by year in at least one area, except for china rockfish. Mean lengths of black rockfish, copper rockfish, olive rockfish increased in all areas between 2007 and 2009; whereas blue rockfish, gopher rockfish, and kelp rockfish had varying trends that changed among areas, and thus no overall mean length yearly trends. We used a two-factor ANOVA, with site and year as factors, to compare the mean lengths of the ten most frequently caught species using hook-and-line gear.

Año Nuevo

For all years combined, mean lengths of black, blue, copper, and yellowtail rockfishes were greater in the MPA site, whereas mean lengths of china, gopher, kelp, and vermilion rockfishes, and lingcod were greater in the REF sites (Figure 22A). Mean lengths of black, blue, copper, gopher, vermilion, and yellowtail rockfishes were significantly different between MPA and REF sites (Table 25). No significant differences in mean length between sites were found for china rockfish, lingcod, or olive rockfish. Overall, mean lengths of black, olive, and yellowtail rockfishes increased between 2007 and 2009, whereas mean length of vermilion rockfish decreased between 2007 and 2009, in both the MPA and REF sites (Table 25, Figure 23).

Point Lobos

For all years combined at Point Lobos, the mean total lengths of black, blue, china, copper, gopher, olive, and vermilion rockfishes were significantly larger inside the MPA compared to the REF site (Table 25, Figure 22). At Point Lobos, a portion of the MPA site that we evaluated had been closed to fishing for 37 years, and differences in mean lengths between that part of the

MPA and the REF site were much greater than in other areas we surveyed. There were no differences in mean lengths of kelp rockfish, lingcod, or yellowtail rockfish between MPA and REF sites. There were no species with greater mean lengths in the REF site. The mean lengths of blue, gopher, and vermilion rockfishes decreased from 2007-2009, whereas mean lengths of olive rockfish steadily increased 2007-2009, in both the MPA and REF sites.

Piedras Blancas

At Piedras Blancas, for all years combined, the mean lengths of copper rockfish, lingcod, olive rockfish, vermilion rockfish and yellowtail rockfish were significantly greater in the MPA site than the REF site, whereas the mean lengths of blue rockfish and gopher rockfish were significantly greater in the REF site. No significant differences in mean lengths were observed for black or kelp rockfishes between sites. Gopher, olive, and yellowtail rockfishes increased in mean length 2008-2009, while lingcod and vermilion rockfish mean lengths decreased (Figure 23).

Point Buchon

In testing data for all years combined in the Point Buchon area, lingcod, and vermilion rockfish showed significantly greater mean lengths in the MPA site, whereas blue, gopher and olive rockfishes had significantly larger mean lengths in the REF site (Table 25). Black, china, copper, kelp, and yellowtail rockfishes did not show any significant difference, (though china, copper, kelp, and yellowtail rockfishes did have greater mean lengths in the REF site, Figure 23). The mean lengths of black, blue, copper, gopher, and yellowtail rockfishes increased from 2007-2009 (kelp rockfish mean length also increased although not significantly). Mean lengths decreased from 2007-2009 for lingcod and vermilion rockfish.

Trap Gear

The total length of each fish captured in the trap surveys was measured to the nearest centimeter. For each species, we first aggregated and then averaged lengths of all fishes caught during the entire study period to evaluate differences between MPA and REF sites in each of the study areas. We then plotted mean lengths of the seven most frequently caught species (Figure 24). We then evaluated differences in mean lengths using randomized-blocked ANOVAs. Assumptions of ANOVAs (normality, equal variances, and no interaction between the two factors of site and year) were tested, and in some cases data were transformed to meet assumptions. Only ANOVA p-values results that met all assumptions are reported. Of the top seven most frequently caught species with trap gear, the general trend was that there was no difference between mean lengths of MPA and REF site lengths (Table 26).

Año Nuevo

At Año Nuevo, the only species to display a significant difference in mean length was black-and-yellow rockfish. MPA mean length of black-and-yellow rockfish was significantly greater than the REF site (Table 26). Mean lengths of all other species were not significantly different between the MPA and REF site. As trapping was only conducted in 2008 at Año Nuevo, no yearly trends could be examined.

Point Lobos

Of the seven species most frequently caught with trap gear at Point Lobos, only mean lengths of black-and-yellow rockfish were significantly different between the MPA and REF sites ($p \leq 0.001$), with the REF site having greater mean lengths (Table 26, Figure 24B)

Piedras Blancas

At Piedras Blancas, mean lengths of only black-and-yellow rockfish were significantly greater in the REF site ($p < 0.001$), whereas cabezon, gopher rockfish, kelp greenling, and lingcod did not show any significant differences in mean length between sites (Table 26, Figure 24C).

Cambria

At Cambria, mean lengths of gopher rockfish and lingcod were significantly greater in the MPA site ($p < 0.05$), whereas mean lengths of black-and-yellow rockfish were greater in the REF site. Additionally, black-and-yellow rockfish, cabezon, and gopher rockfishes had greater lengths in 2009 than 2008 (Table 26, Figure 24D).

Comparisons of Length Frequencies to Female Lengths at Maturity

A useful metric in assessing the status or “health” of fish populations is the percentage of mature fish in the population (O’Farrell and Botsford 2006). We identified the 25th percentile, median, and 75th percentile of measured lengths for each species, and then evaluated the percentages of potentially mature fish in the study areas by comparing our data to the published lengths at 50% and 100% maturity for females (Table 27, Table 28). Length at 50% maturity (F50%) for females indicates that any given female fish of that length has a 50% chance of being mature.

Hook-and-line Gear

Several trends in fish size were present across all areas simultaneously. Foremost, most of the yellowtail and black rockfishes caught were below the lengths of 50% maturity for females. In general, median lengths of blue rockfish were well below the lengths of 50% maturity, with the 75th percentile lengths barely reaching or exceeding the lengths of 50% maturity. Median and 75th percentile lengths of lingcod, olive rockfish, and vermilion rockfish were usually at or above the lengths of 50% maturity, though these species exhibited variability among years, sites, and areas (Figure 25). Stocks that seem relatively healthy were the china rockfish, gopher rockfish and kelp rockfish, because their median and 75th percentile lengths were consistently above the lengths of 50% maturity. Notably, the 25th percentile lengths of gopher and kelp rockfishes were several centimeters above lengths of 50% maturity. When observing differences between MPA and REF sites, the 75th percentile lengths of black rockfish, blue rockfish, copper rockfish, lingcod, and vermilion rockfishes most species were usually larger in MPAs than at REF sites, depending on area. The opposite wasn’t consistently true for any of the most frequently caught species.

Black rockfish

From the literature, the length at 50% maturity for female black rockfish females is 41.0 cm total length, which corresponds to 7 years of age (Table 27). As mentioned before, black rockfish were consistently below the length at 50% maturity for all areas (Table 29). Only a few larger, outlying individuals were caught at or above the length of 50% maturity (Figure 25A). In Año Nuevo, 6 out of 1158 fish (<1%) that were caught in the REF sites from 2007-2009, and 2 out of 575 caught in the MPA site from 2007-2009, were above F50%. In Point Buchon, 1 out of 253 black rockfish caught in the REF site was above the length of 50% maturity. No black rockfish over 41.0 cm were caught in the Point Lobos or Piedras Blancas areas. This means a sum total of 9 black rockfish out of 2,515 caught (0.4%) were above the length of 50% maturity in this entire study (Table 30).

Blue rockfish

The length at 50% maturity for blue rockfish females is 29.0 cm total length, which corresponds to an age of 6 years (Table 27). At Año Nuevo, 188 out of 705 fish (27%) in the MPA 2007-2009, and 127 out of 905 (14%) in the REF 2007-2009 were at or above the length at 50% maturity. At Point Lobos, 1627 out of 2949 fish (55%) caught MPA site and 360 out of 930 fish (39%) in the REF site were at or above F50%. Looking just within the Point Lobos MPA, 1492 out of 2593 fish (58%) were at or above the length at 50% maturity in the OLD section and 81 out of 260 fish (31%) were at or above F50% in the NEW section of the MPA. At Piedras Blancas, 137 out of 494 fish (28%) in the MPA and 195 out of 371 (53%) in the REF site were at or above F50%. At Point Buchon, 202 out of 747 fish (27%) in the MPA and 88 out of 355 fish (25%) in the REF site were at or above F50%. Obviously, the largest percentage of fish likely to be mature is from the Point Lobos area, specifically from the OLD section of the MPA. In total, 39% of the blue rockfish caught (2,923 fish) were at or above the length of 50% maturity (Table 30).

China rockfish

The length at 50% maturity for china rockfish females is 27.0 cm total length, which corresponds to an age of 4 years (Table 27). Nearly all the median and 75th percentile lengths of caught fish were above length at 50% maturity, except at the Point Lobos REF site in 2007 (Table 29, Figure 25C). At Año Nuevo, 20 out of 28 fish (71%) in the MPA site and 69 out of 79 fish (87%) in the REF site were at or above F50%. At Point Lobos, 71 out of 79 fish (90%) in the MPA and 14 out of 24 (58%) in the REF were at or above F50%. Looking just at the Point Lobos MPA, 48 out of 54 fish (89%) in the OLD section and 22 out of 24 (91%) in the NEW section were at or above F50%. In Piedras Blancas, china rockfish were only caught in the MPA site, and 16 out of 19 (84%) of those fish were at or above F50%. In Point Buchon, 26 out of 31 fish (84%) in the MPA site and 5 out of 7 fish (71%) in the REF site were at or above F50%. Summing all areas, 83% of the china rockfish (221 fish out of 267 caught) were at or above the length at 50% maturity. Therefore, across all areas and by site, china rockfish removed via hook-and-line fisheries were comprised largely of fish that are likely reproductive (Table 30).

Copper rockfish

The length at 50% maturity for copper rockfish females is 34.0 cm total length, which corresponds to about 6 years of age (Table 27). Different areas had different distributions around

the length at 50% maturity. Median lengths of copper rockfish were higher at Point Lobos and Piedras Blancas than Año Nuevo and Point Buchon, however Point Lobos and Piedras Blancas showed broader size distributions (Table 29, Figure 25D). In the Año Nuevo MPA, 6 out of 10 fish caught were at or above the F50%. In Point Lobos, 105 out of 125 fish (84%) caught in the MPA and 15 out of 28 (54%) in the REF site were at or above F50%. Within the Point Lobos MPA, 97 out of 116 fish (84%) caught in the OLD section and 8 out of 9 fish in the NEW section, were at or above F50%. In Piedras Blancas, 64 out of 72 fish (89%) caught in the MPA and 28 out of 55 fish (51%) caught in the REF site were at or above F50%. In Point Buchon, 3 out of 18 fish caught in the MPA were at or above F50%, as were 6 out of 19 fish from the REF site. Summing all copper rockfish caught, 69% (227 out of 328) were at or above the length at 50% maturity (Table 30).

Gopher rockfish

The length at 50% maturity for gopher rockfish is 17.0 cm total length, which is about 4 years of age (Table 27). In all areas, the 25th percentile, median, and 75th percentile lengths were above F50% by several cm in all cases, and above the length at 100% maturity (21.0 cm) as well (Table 29, Figure 25E). Examining all the catch, 6,773 out of 6,777 gopher rockfish caught (>99%) were at or above the length at 50% maturity, indicating that the hook-and-line fishery primarily removes fish that have had a chance to reproduce (Table 30).

Kelp rockfish

The length at 50% maturity for kelp rockfish is 21.2 cm total length, at 3-4 years of age (Table 27). The 25th percentile, median, and 75th percentile lengths from all areas, sites, and years was well above the F50%, and also a majority of the catch was also above 28.0 cm, the length at 100% maturity (Figure 25F, Table 29). In all the kelp rockfish caught, only one was below the length at 50% maturity, indicating that this species is responding well to hook-and-line removals over time (Table 30).

Lingcod

The length at 50% maturity for lingcod is 57.3 cm total length, which is about 3.8 years of age (Table 27). Compared to the other ten most frequently caught species, the length distributions of lingcod are highly variable, probably due primarily to the difference in its growth rate and biology when compared to that of the rockfishes (Figure 25G, Table 29). At Año Nuevo, 43 out of 72 fish (60%) caught in the MPA and 26 out of 43 of fish (61%) in the REF were at or above F50%. In Point Lobos, 51 out of 79 fish (65%) caught in the MPA and 11 out of 25 fish (44%) in the REF site, were at or above F50%. Within the Point Lobos MPA, 45 out of 66 lingcod (68%) caught in the OLD section and 4 out of 10 fish caught in the NEW section were at or above F50%. In Piedras Blancas, 25 out of 49 lingcod (51%) caught in the MPA and 15 out of 37 fish (41%) in the REF site were at or above F50%. In Point Buchon, 33 out of 85 lingcod (39%) caught in the MPA and 30 out of 85 fish (35%) caught in the REF site were at or above F50%. Summing the total catch, 49% of the lingcod caught (234 out of 475 fish) were at or above the length at 50% maturity (Table 30).

Olive rockfish

The length at 50% maturity for olive rockfish is 35.0 cm total length, which corresponds to an age of about 5 years (Table 27). The length distributions of olive rockfish were highly variable, with 75th percentile lengths being consistently at or above F50% only in the Point Lobos and Piedras Blancas areas (Figure 25H, Table 29). Few olive rockfish were caught at Año Nuevo. In Point Lobos, 632 out of 966 fish (65%) caught in the MPA and 118 out of 219 fish (54%) caught in the REF site were at or above F50%. Within the Point Lobos MPA, 512 out of 781 olive rockfish (66%) caught in the OLD section and 106 out of 165 fish (64%) from the NEW section were at or above F50%. In Piedras Blancas, 286 out of 379 fish (76%) caught in the MPA and 32 out of 76 (42%) in the REF site were at or above F50%. In Point Buchon, 21 out of 104 fish (20%) caught in the MPA and 18 out of 69 fish (26%), in the REF site were at or above F50%. Across all areas, 61% (1113 out of 1833 fish) of all olive rockfish caught were at or above the length at 50% maturity (Table 30).

Vermilion rockfish

The length at 50% maturity for vermillion rockfish is 37.0 cm total length, corresponding to an age of 5 years (Table 27). The 75th percentile lengths of the whisker-plots usually were above F50%, and in a majority of the cases, the median lengths were also above F50% (Figure 25I, Table 29). At Año Nuevo, 17 out of 28 fish caught in the MPA and 22 out of 42 in the REF site were at or above F50%. In Point Lobos, 40 out of 51 fish (83%) caught in the MPA and 19 out of 25 fish (73%) in the REF site were at or above F50%. Within the Point Lobos MPA, 90 out of 106 fish (85%) caught in the OLD section and 9 out of 14 in the NEW section were at or above F50%. In Piedras Blancas, 195 out of 235 fish (83%) caught in the MPA and 112 out of 169 fish (66%) in the REF site were at or above F50%. In Point Buchon, 40 out of 51 fish (78%) caught in the MPA and 18 out of 54 fish (33%) in the REF site were at or above F50%. Summing catch from all areas, sites, and years, 70% of vermillion rockfish caught (524 out of 747 fish) were at or above the length at 50% maturity. For all but the Año Nuevo area, it seems that the MPAs hold a larger percentage of possibly reproductive fish than the REF sites (Table 30).

Yellowtail rockfish

The length at 50% maturity for yellowtail rockfish is 36.0 cm total length, at an age of about 7 years (Table 27). Overall, the 75th percentile lengths were below the F50% for all areas, sites, and years, and only a few fish were caught that were larger than F50% (Figure 25J, Table 29). Across all areas, only 3% of yellowtail rockfish caught (16 out of 470 fish) was at or above the length at 50% maturity (Table 30). This reflects the ontogenetic movement of yellowtail rockfish, which settle in kelp beds and move to deeper habitats as they grow.

Trap Gear

The vast majority of the catch from traps consisted of fishes that were well above the length at 50% maturity (Table 31). The 25th percentile lengths of the catch of black and yellow rockfish, gopher rockfish, and kelp greenling were all above the length at 50% maturity for all areas, sites, and years (Table 32). Grass rockfish and treefish were caught much less regularly, but when captured, their 25th percentile and median lengths were also well above F50%. Cabezon also displayed 25th percentile lengths that were above F50%. Lingcod median and 75th percentile lengths were usually above F50%. It is unclear from our data whether these catches of

larger fishes are due to the catch of species whose stocks are currently healthy or if the traps select for larger fishes. If the latter is the case, the cause of the gear (catchability) bias could be linked to the fish behavior in two ways: 1) when competing for the same food resource (the bait), larger specimens of territorial species, such as black-and yellow rockfish and gopher rockfish, drive smaller individuals away from the trap (Larson 1980), and/or 2) smaller individuals are better able to escape from the trap before the trap surfaces.

Skewness of Length-Frequency Distributions

As a spatially based management tool, one of the main goals of MPAs is to protect marine fishes by protecting habitat and creating refuge from fisheries by restricting use in strategic areas. The expectation is that at the time of closure, the differences between MPA and REF sites will be negligible with the exception of the old section of the Point Lobos MPA, which had been closed to fishing for 34 years at the time of the establishment of the new MPAs. As the new MPA sites remain closed over time, it is expected that there will be a shift in length frequencies between sites, with fish growing to larger sizes in the MPA sites.

We were interested in determining if the frequency distribution was skewed to the right in MPA sites relative to REF sites, which would indicate a greater abundance of large fishes in MPAs. Using two sample K-S tests, the length frequency distributions of the ten most frequently caught hook-and-line species and the seven most frequently caught trapping species were compared between MPA and REF sites among all areas surveyed.

Hook-and-line Gear

At Año Nuevo, length frequency distributions of black, blue, and yellowtail rockfishes were significantly skewed towards larger fish in the MPA, whereas frequency distribution of gopher rockfish was skewed towards larger fish in the REF site (Table 33). All the length frequency distributions of fishes, except for vermilion and yellowtail rockfishes caught at Point Lobos were significantly skewed towards larger fish in the MPA (Table 33). At Piedras Blancas, length frequency distributions of copper, olive, vermilion, and yellowtail rockfishes were significantly skewed towards larger fish in the MPA, whereas length frequency distributions of blue rockfish were skewed towards larger fish in the REF site. At Point Buchon, the length frequency distribution of vermilion rockfish was skewed towards larger fish in the MPA, whereas length frequency distributions of blue and gopher rockfishes were skewed towards larger fish in the REF site.

Trap Gear

In most cases, the length frequency distributions of fishes caught in the trap surveys in the MPA and REF sites were not significantly different ($p > 0.05$) except in the case of black-and-yellow rockfish, in which larger fish were caught in the REF sites at Point Lobos, Cambria, Piedras Blancas (Table 34). The only incidences of length distributions being significantly larger in the MPA vs. REF site were for gopher rockfish at Point Lobos and Cambria (Table 34). It should be noted that only the four most commonly caught species in the trapping surveys (black and yellow rockfish, gopher rockfish, cabezon, and kelp greenling) were caught frequently enough to make valid comparisons in all areas. The remaining three species were not caught in sufficiently large numbers to make valid statistical comparisons.

5) What is the likelihood of spillover of different species inhabiting MPAs?

Tag Recaptures

As of April 1, 2010, 153 individual tag recaptures (<1% return) have been reported to CCFRP (Table 35). Tagged fishes were recaptured during our sampling and by fishermen, divers, and beach-combers (who found tags on the beach). Identification numbers were reported from tags deployed from all areas, sites, and years encompassed by our study, with the majority of the returns coming from fishes caught and released in the hook-and-line section of the project from 2007-2008 (65%). The trapping component of sampling for 2008 also contributed a large part of the tag returns (28%). Out of the 153 reported tags, 119 were still attached to the fish we released, and were reported with some sort of useful information relating to the location and date of capture, fish species, fish health, fish length, tag bio-fouling, and whether or not the fish was re-released or retained. Some tag recaptures, while reported to our offices, were not accurately recorded and/or did not contain enough detailed information to be useful in calculating distance moved. Of the ten most frequently caught species using hook-and-line gear, individuals of all but kelp and vermilion rockfishes were recaptured and reported. Of the seven commonly caught species in the trap surveys, all but grass rockfish and treefish were recaptured and reported.

For the most part, net movements estimated from tag recaptures fall within expected fish movements for the recaptured species in central California. There were some cases of fish moving further than expected for their species, however the degree of accuracy in location reporting those fish is unverified (Table 36). For this reason, fish movements are separated by party reporting on Table 35, and previously observed fish movements for a species found in the literature are presented for comparison.

For all the tag recaptures recorded in this study, 63% of the fish were recaptured in the same site and grid cell as they were released. A total of 22% fish was recaptured within the same site (MPA or REF) as they were tagged, but outside the grid cell of release. Only 18 fish, or 15% of the recaptures, had traveled beyond the boundaries of the MPA or REF site in which they were released. In some cases, this represented spillover movement from the MPA (Table 37). An example of net movements within a study area, site, and grid cells is displayed in Figure 26.

The furthest movement from the release location was that of a black rockfish, released from an Año Nuevo MPA site, that traveled 886 km in 312 days. The second largest movement was also a black rockfish, released from the Point Lobos REF; it traveled 684 km in 299 days (Table 36). The least amount of distance moved was shared by two gopher rockfish that were released together on the same drift in a Cambria REF site and recaptured 409 days later in the same spot, for a net total movement of <0.1 km. The longest time at liberty came from a gopher rockfish that was at liberty for 729 days and displayed a net movement of 1.3 km. The shortest time at liberty is held by two copper rockfish, one recaptured in the Point Lobos MPA and one recaptured in the Piedras Blancas REF; each had been at liberty for less than 6 hours before being recaptured by CCFRP later that day within the same site. All the ranges and means of days at liberty and distance moved are reported in Table 37 for each species. Of note, two kelp greenlings were released on the same day were recaptured 317 days later in the Cambria MPA. Those fish that had moved 0.02 and 0.03 km, respectively in 317 days. As CCFRP recaptured these two fish, the degree of recapture location accuracy is great, and these two movement data are very valuable as information of kelp greenling movement is very sparse to non-existent.

Over the time span of January to mid-March 2010, 30 loose tags washed up on Carmel Beach, CA and were found by beach-combers and CA DFG employees amidst beach and kelp wrack (Table 37). All but one of these tags had been inserted into a fish that was successfully released (the one tag was not recorded as being deployed); and all but one of the tags found on Carmel Beach came from fish we had released back to the Point Lobos MPA and REF sites (the one tag being from a fish released in the Año Nuevo MPA). Two tags were also found on beaches near the Año Nuevo study area; one came from a fish released in the Año REF site and the other coming from a fish released in the Point Lobos MPA. These tags were all described as clean (without bio-fouling), with the base of the tag still attached (the top of the ‘T’ that keeps the tag inside the fishes’ musculature.)

We hypothesize that the group of tags found on Carmel Beach represented the plastic and wrack that had been accumulated and held in the ‘Carmel ocean gyre’ for several years, which was eventually deposited onshore due to different current movements and storm patterns experienced the winter of 2010. Other projects that involved animal tagging from CDFG and MLML fish tagging (similar tags and methods to this project) and pinned flipper tags were also found over a series of weeks in the same location, along with other floating plastic refuse.

Acknowledgements

The California Collaborative Fisheries Research Program team would like to thank the multitude of people who have helped us over the years in creating and carrying out this project. This project has been a true collaboration among the fishing, resource agency, academic, and public communities. Foremost we would like to thank all the captains, skippers, deckhands, and volunteers who have advised and worked with us throughout this project. You are truly indispensable; your fisheries experience was essential to the success of this project. Your cooperation was much appreciated, and your friendship is very valued. We would like to dedicate this report to the memory of Gary Christensen, who died at sea in January. Gary was a very skilled deckhand who worked with us in the surveys of Año Nuevo. Gary always brightened up our mornings with good humor and lightened our work at sea. He will be missed.

We extend a special thanks to Don Maruska who has been extremely helpful in providing inspiration and funding for this work. We thank the many members of the CA Department of Fish and Game who participated in the study trips, sharing not only sound logistical and scientific sampling advice, but also volunteering time as science crew and volunteer anglers. Thank you to the students from Moss Landing Marine Labs and Cal Poly San Luis Obispo who volunteered as science crews on our trips. The data were collected, entered, and analyzed by a small army of determined graduate students. John Stevens continues to provide excellent guidance to students from Cal Poly San Luis Obispo. Also, many interns have helped us over the years, often these people volunteered their time to help as science crew. A special thanks to intern Daniel Adams, who often went the extra mile to help us when we needed it. Thanks to Joe King, Ho Tackle, and Ace Calloway who have assisted us in finding and providing the necessary fishing/descending gear consistently over the years, as well as making it more affordable for our research.

Finally thanks to all the volunteer anglers who have fished for us during our hook-and-line sampling trips. Our volunteer crew now totals 415 people, who collectively have contributed more than 9,000 hours of their time. Many anglers were dependable return fishers, whose dedication is just as strong as ours. Congratulations, this is your report as well! To everyone, we sincerely hope we will be fishing together for years to come.

This project was made possible due to funding from the Ocean Protection Council, California Sea Grant College Program, Moss Landing Marine Labs, San Jose State University Foundation, Cal Poly San Luis Obispo, the Campbell Foundation, the Packard Foundation, the Moore Foundation, and the Resources Legacy Fund Foundation.

References

- Allen, L. G., D. J. Pondella II, and M. H. Horn. 2006. The ecology of marine fishes: California and adjacent waters. University of California Press, Berkeley, CA. Pg: 524-553.
- Colton, M.A. and R.J. Larson. 2007. Aspects of the life history of treefish, *Sebastes serriceps* (Sebastidae). CalCOFI Rep. 48:177-190.
- Cope, J.M. and A.E. Punt. 2005. Status of Cabezon (*Scorpaenichthys marmoratus*) in California Waters as Assessed in 2005. In Status of the Pacific coast groundfish fishery through 2005, stock assessment and fishery evaluation: stock assessments and rebuilding analyses (volumes I-VII). Portland, OR: Pacific Fishery Management Council.
- DeMott, G. E. 1983. Movement of tagged lingcod and rockfishes off Depoe Bay, Oregon. M. S. Thesis. Oregon State University, Corvallis, OR.
- Echeverria, T. and W.H. Lenarz. 1984. Conversions between total, fork, and standard lengths in 35 species of *Sebastes* from California. Calif. Dept. Fish and Game, Fish. Bull. 82:249-251.
- Faith, D. P., P. R. Minchin, and L. Belbin. 1987. Compositional dissimilarity as a robust measure of ecological distance. *Vegetatio* 69:57-68.
- Field, J.C., E.J. Dick, D. Pearson and A.D. MacCall. Status of Boccacio, *Sebastes paucispinis*, in the Conception, Monterey and Eureka INPF areas for 2009. In Status of the Pacific Coast Groundfish Fishery through 2009, Stock Assessment and Fishery Evaluation: Stock Assessments, STAR Panel Reports, and Rebuilding Analyses. Portland, OR: Pacific Fishery Management Council.
- Freiwald, Jan. Personal communication: Regarding regular movement patterns of kelp greenling (*Hexagrammos decagrammus*) in Central California. April 2010.
- Garson, G. D. Testing of Assumptions: Statnotes, from North Carolina State University, Public Administration Program. Online: 21 April 2010.
- Grebel, J. 2003. Age, growth, and maturity of cabezon, *Scorpaenichthys marmoratus*, in California. M.S. thesis, Moss Landing Marine Laboratories.
- Gotelli, N. J., and A. M. Ellison. 2004. A Primer of Ecological Statistics. Sinauer Associates, Inc., Sunderland, MA.
- Hamel, O.S., S.A. Sethi, and T.F. Wadsworth. 2009. Status and future prospects for lingcod in waters off Washington, Oregon, and California as assessed in 2009. In Status of the Pacific Coast Groundfish Fishery through 2009, Stock Assessment and Fishery Evaluation: Stock Assessments, STAR Panel Reports, and Rebuilding Analyses. Portland, OR: Pacific Fishery Management Council.
- Hartmann, A. R. 1987. Movements of Scorpionfishes (*Scorpaenidae: Sebastes* and *Scorpaena*) in the southern California Bight. *Calif. Fish and Game*. 73(2): 68-79.

- Karpov, K.A., D.P. Albin, and W.H.V. Buskirk. 1995. The marine recreational fishery in northern and central California: A historical comparison (1958-86), status of stocks (1980-86), and effects of changes in the California current. Calif. Dept. Fish and Game, Fish. Bull. 176:192.
- Karpov, K. A. personal communication: "Karpov, K., P. Kalvass, M. Patyten, M. Prall, D. Sweetnam, and D. Albin. 2000. Draft. Summary report: Nearshore reef fish investigations."
- Key, M., A.D. MacCall, T. Bishop, and B. Leos. 2005. Stock assessment of the gopher rockfish (*Sebastes carnatus*). In Status of the Pacific coast groundfish fishery through 2005, stock assessment and fishery evaluation: stock assessments and rebuilding analyses (volumes I-VII). Portland, OR: Pacific Fishery Management Council.
- Key, M., A.D. MacCall, J. Field, D. Aseltine-Neilson, and K. Lynn. 2008. The 2007 assessment of blue rockfish (*Sebastes mystinus*) in California. In Status of the Pacific coast groundfish fishery through 2008, stock assessment and fishery evaluation: stock assessments, STAR panel reports, and rebuilding analyses. Portland, OR: Pacific Fishery Management Council.
- Kvitek, R. 2010. Seafloor Mapping Lab remote imagery. <http://seafloor.csUMB.edu/index.html>, Accessed May 24, 2010.
- Laidig, T.E., P.B. Adams, K.R. Siberberg, and H.E. Fish. 1997. Conversions between total, fork, and standard lengths for lingcod, *Ophiodon elongatus*. Calif. Fish and Game 83(3):128-129.
- Laidig, T.E., D.E. Pearson, and L.L. Sinclair. 2003. Age and growth of blue rockfish (*Sebastes mystinus*) from central and northern California. Calif. Dept. Fish and Game, Fish. Bull. 101:800-808.
- Larson, R. 1980. Competition, habitat selection, and the bathymetric segregation of two rockfish (*Sebastes*) species. Ecological Monographs. 50(2):221-239.
- Lea, R.N., R.D. McAllister, and D.A. VenTresca. 1999. Biological aspects of nearshore rockfishes of the genus *Sebastes* from central California. Calif. Dept. Fish and Game, Fish. Bull. 177.
- Leaman, B.M. and R.J. Beamish. 1984. Ecological and management implications of longevity in some Northeast Pacific groundfishes. International North Pacific Fisheries Commission. Bulletin42:85-97.
- Love, M.S. and K. Johnson. 1998. Aspects of the life histories of grass rockfish, *Sebastes rastrelliger*, and brown rockfish, *S. auriculatus*, from southern California. Fish. Bull. U.S. 87:100-109.
- Love, M.S. and W.V. Westphal. 1981. Growth, reproduction, and food habits of olive rockfish, *Sebastes serranoides*, off central California. Fish. Bull. U.S. 79(3):533-545.
- Love, M.S., M.M. Yoklavich, and L. Thorsteinson. 2002. The rockfishes of the Northeast Pacific. University of California Press, Berkeley, CA.

- MacCall, A.D. 2005. Assessment of Vermilion Rockfish in Southern and Northern California. In Status of the Pacific coast groundfish fishery through 2005, stock assessment and fishery evaluation: stock assessments and rebuilding analyses (volumes I-VII). Portland, OR: Pacific Fishery Management Council.
- Mason, J. E. 1998. Declining rockfish lengths in the Monterey Bay, California, recreational fishery, 1959-94. *Marine Fisheries Review*. 60(3):15-28.
- Matthews, K.R. 1986. Movement of two nearshore, territorial rockfishes previously reported as non-movers and implications to management. *Calif. Fish and Game* 72(2):103-109.
- Miller, D.J., M.W. Odemar, and D.W. Gotshall. 1967. Life history and catch analysis of the blue rockfish (*Sebastes mystinus*) off central California, 1961-1965. *Calif. Dept. Fish and Game, Mar. Resources Operations Ref.* 67-14.
- Miller, D. J., and J. J. Geibel. 1973. Summary of blue rockfish and lingcod life histories; a reef ecology study; and giant kelp, *Macrocystis pyrifera*, experiments in Monterey Bay, California. *Calif. Dep. Fish and Game, Fish Bull.* 158.
- Norris, R.M., and R.W. Webb. 1990. *Geology of California*. 2nd Edition. John Wiley & Sons, Inc. New York, New York.
- Norusis, M.J. 2002. *SPSS 11.0: Guide to data analysis*. Prentice-Hall, Upper Saddle River, NJ.
- O'Connell, C.P. 1953. The life history of the cabezon, *Scorpaenichthys marmoratus* (Ayres). *Calif. Dept. Fish and Game, Fish Bull.* 93.
- O'Farrell, M.R. and L.W. Botsford. 2006. Estimating the status of nearshore rockfish (*Sebastes* spp.) populations with length frequency data. *Ecological Applications*.16(3):977-86.
- Oksanen J., F.G. Blanchet, R. Kindt, P. Legendre, R.B. O'Hara, G.L. Simpson, P. Solymos, M.H.H. Stevens, and H. Wagner. *Vegan: Community ecology package*. R package version 1.17-2. <http://CRAN.R-project.org/package=vegan>. March 17, 2010.
- Ormsby, T., E. Napoleon, R. Burke, C. Groessl, and L. Feaster. 2004. *Getting to know ArcGIS desktop*. ESRI Press, Redlands, CA.
- Phillips, J.B. 1959. A review of the lingcod, *Ophiodon elongatus*. *Calif. Fish and Game* 45(1): 19-27.
- Phillips, J.B. 1964. Life history studies on ten species of rockfish (Genus *Sebastes*). *Calif. Dept. Fish and Game, Fish Bull.* 126:1-70.
- Quinn, G.P. and M.J. Keough. 2002. *Experimental design and data analysis for biologists*. Cambridge University Press, Cambridge, UK.
- Reilly, P.N. D. Wilson-Vandenberg, R.N. Lea, C. Wilson, and M. Sullivan. 1994. *Recreational angler's guide to the common nearshore fishes of northern and central California*. *Calif. Dept. Fish and Game, Mar. Resources Leaflet*.

- Renokonen, O. 1938. Statisch–ökologische Untersuchungen über die terrestrische kaferwelt der finnischen bruchmoore. *Annales Botanici Societatis Zoologica-Botanica Fennica* “Vanamo” 6: 1–231.
- Romero, M. 1988. Life history of the kelp rockfish, *Sebastes atrovirens* (Scorpaenidae). M.S. thesis, San Francisco State University. In Love, M. S., M. Yoklavich, and L. Thorsteinson. 2002. *The rockfishes of the Northeast Pacific*. University of California Press, Berkeley and Los Angeles, CA. 126-128.
- Rosenthal, R.J., L. Haldorson, L.J. Field, V. Moran-O'Connell, M.G. LaRiviere, J. Underwood, and M.C. Murphy. 1982. Inshore and shallow off-shore bottomfish resources in the southeastern Gulf of Alaska (1981-1982). Alaska Dept. Fish and Game, Juneau, Alaska.
- Rothrock, G.C. 1973. Age-length, weight, fecundity, and meristics of the kelp greenling, (*Hexagrammos decagrammus*), off California. M.S. Thesis, University of California, Davis.
- Silberberg, K.R., T.E. Laidig, P.B. Adams, and D. Albin. 2001. Analysis of maturity in lingcod (*Ophiodon elongatus*). Calif. Fish and Game 87(4): 139-152.
- Starr, R.M., J.M. Cope, and L.A. Kerr. 2002. Trends in fisheries and fishery resources associated with the Monterey Bay National Marine Sanctuary from 1981–2001. California Sea Grant College System Publication T-046.
- Starr, R. M., V. O’Connell, and S. Ralston. 2004. Movements of lingcod (*Ophiodon elongatus*) in southeast Alaska: potential for increased conservation and yield from marine reserves. *Can. J. Fish. Aquat. Sci.* 61:1083-1094.
- Stewart, I.J. 2007. Status of the U.S. canary rockfish resource in 2007. In Status of the Pacific coast groundfish fishery through 2008, stock assessment and fishery evaluation: stock assessments, STAR panel reports, and rebuilding analyses. Portland, OR: Pacific Fishery Management Council.
- Wagner, D.L., H.G. Greene, G.J. Saucedo, and C.L. Pridmore. 2002. Geologic map of the Monterey 30’x60’ quadrangle and adjacent areas, California. Digitized by S.E. Watkins, J.D. Little, and J.J. Bizzarro.
- Weber, M.L. and B. Heneman. 2000. Guide to California’s marine life management act. Common Knowledge Press, Bolinas, CA.
- Wertz, L.A. and S. Kato. 2004. Ocean whitefish. In *Annual status of the fisheries report through 2003. 2004. Calif. Fish and Game*.
- Wyllie-Echeverria, T. 1987. Thirty-four species of California rockfishes: maturity and seasonality of reproduction. *Fish. Bull. U.S.* 85(2): 229-250.
- Zar, J.H. 1999. Biostatistical analysis. Prentice-Hall, Upper Saddle River, NJ.

Appendix 1- Survey Protocols

Hook-and-line

Within each MPA or REF site, we identified nearshore rock habitats to survey by using seafloor maps and depth charts. We then used a GIS to stratify the habitats into 500 x 500 meter grid cells. These cells were used to delineate and randomly select sampling locations to ensure representative sampling occurred within the site over areas of suitable and similar habitat. For hook-and-line surveys, a total of 22 grid cells in Año Nuevo, 17 in Point Lobos, 57 in Piedras Blancas, and 22 in Point Buchon were generated. The grid cells were positioned in nearshore rocky habitats, in water less than 40 meters deep for hook-and-line sampling, to limit fish mortality from barotrauma.

During each day of sampling, four of the grid cells (in a given MPA or REF site) were chosen at random and sampled. In the morning, the captain was provided with the coordinates of the sampling cell and asked to fish in each cell in locations where he thought the catch would be best. A total sampling time of 1½ hr was allotted for each grid cell in a sampling year (i.e. for each grid cell to be sampled twice in a year). In order to account for the variability within each cell, the goal was to locate three suitable fishing locations within each grid cell and complete a fishing drift of 15 minutes for each location. Location terminology is explained in App. Figure 1. If a single 15-minute drift was not possible, due to strong currents or other reasons, the captain could choose to make several drifts in the same location for a combined total of 10-15 minutes. The objective was to fish in three discrete locations within the grid cell for a total of at least 30 minutes, but no more than 45 minutes, for a day.

We recruited volunteer anglers to help fish in the hook-and-line portion of this study. Anglers were recruited from various fishing clubs, online fishing websites, and from previous collaborative fishing studies. We required that all volunteer anglers were somewhat experienced with rockfish fishing, over the age of 16, and capable of fishing consistently for six hours. At the beginning of each fishing day, all volunteer anglers were assigned a fishing station according to experience and, if possible, preference. Six to twelve fishing stations were organized by gear type, with the more-experienced bow anglers fishing hard tackle, (i.e., lingcod bars that ranged in color), at the terminal end of the gear with a shrimp fly teaser, starboard anglers fishing two shrimp fly lures without baits, and port anglers fishing two shrimp fly lures with strips of squid bait. Lingcod bars ranged in weight from 4 to 10 oz, in 2 oz increments, and all shrimp fly tackle consisted of a main/hook line test of 60/30 lbs respectively, and a single 4/0 hook. Shrimp flies used were red and/or white, as recommended by boat captains, and an attempt to distribute the colors evenly during sampling was made to reduce possible bias in catchability due to color. All hooks were single, and were either barbless (lingcod bars), or the barbs were crimped down using pliers to minimize hook damage to fishes. The deckhand was asked to rig the gear for each fishing drift with the lightest sinker and/or lingcod bar that could best perform under the prevailing conditions, to counteract the current and drift, to get the line to the bottom as fast as possible. The number of anglers that fished at a given time was controlled so that each gear type was always fished with equal effort each drift. If volunteer anglers became unable to fish at any point during a trip, or enough anglers did not sign up for that fishing day, members of the science crew would fish the abandoned station to balance the sampling among gear types and complete the sampling day.

Once on drift location, the captain signaled the start of the fishing drift, and the anglers would commence fishing and recorded fishing time began. For each drift, the number of anglers

fishing, start/end locations, any addition or subtraction of angler time fishing, the presence or absence of pinneped, birds, and kelp, start/end depths, and any other comments were recorded on datasheets. When a fish was caught, it was identified to species, measured (total length to the nearest centimeter), tagged with an external T-bar anchor tag (unless the fish was in poor condition or was too small), sexed if possible, and released. The location (latitude and longitude) and depth where a fish was released was also recorded. In order to reduce incidental mortality, fish were placed in fresh seawater tubs until data processing was possible, great care was taken when handling the fishes, on-board time was kept to a minimum (less than 10 minutes), and if affected by barotrauma, fish were vented with hypodermic needles and/or descended using various devices. Caught fishes were released after processing, except for a sub-sample of gopher rockfish collected in 2008 and 2009, which were retained for a diet study that will be completed by a Moss Landing Marine Laboratories student. The retained fish were measured, tagged, euthanized, put in an ice chest, and later bagged and frozen. If a high catch rate precluded rapid processing of the captured fishes, anglers were instructed to stop fishing so that all the fish on board could be processed and released before fishing began again.

Environmental data were recorded daily, such as water temperature at depth using a continuously recording sensor that took temperature and pressure readings, surface water temperature, water clarity measured with a secchi disc, and observations on the weather, wind, swell, amount of relief, and, if possible, current direction and speed.

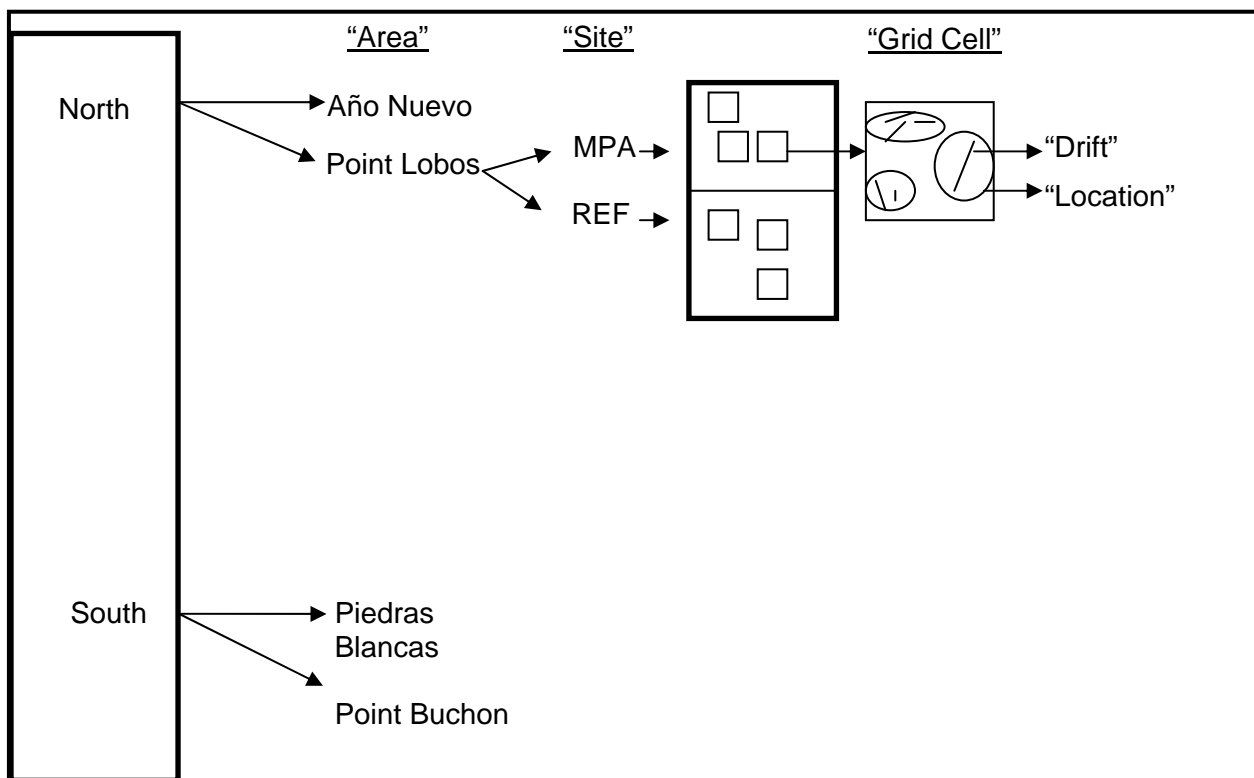

Appendix Figure 1. Terminology used to identify various levels of location information. Sampling was completed in four “Areas.” In the north, there are two areas: Año Nuevo and Point Lobos. In the south, there are two areas: Piedras Blancas and Point Buchon. Within each of these areas, there are two different “Sites:” either Marine Protected Area (MPA) or reference (REF). Within these sites are “Grid Cells,” which delineate the sampling boundaries. In each of the grid cells “Drifts” were completed in three distinct “locations.”

Trapping

In 2008, with the addition of the trapping portion of this program, Tom Hafer, a commercial fisherman from Half Moon Bay, designed a trap that was similar to those used in the live fin-fish fishery, but would also suit our sampling needs (Appendix Figure 2). For trap sampling, 500 x 500 m grid cells were created to designate sampling locations within MPA and REF sites for all areas. Equal number of grid cells were created for the MPA and REF sites; Año Nuevo contained 12 grid cells, Point Lobos contained 16 grid cells, Cambria contained 28 grid cells, and Piedras Blancas contained 36 grid cells. Grid cells were created to encompass 500 m by 500 m areas, in water that is 3-20 meters deep and in locations that live fin-fish fishermen had previously identified as having suitable habitat for nearshore fishes.

At the beginning of these surveys, the goal was to sample three grid cells per day, two days in the MPA and REF sites each month, with three sampling months in a sampling year. In practice, sampling three grid cells per day proved logistically difficult, so the goal grid cell number per day was decreased to two grid cells per day. This remained in effect for the 2009 sample season as well, though the goal of sampling two days per month was decreased to one in the MPA and REF sites each month due to budget constraints. There was an attempt to dedicate one sampling day to sampling one site only, but due to weather, in some rare cases MPA and REF sites for an area were sampled the in same day.

Each sampling day, 2-4 grid cells were randomly selected and sampled according to captain advice and prevailing weather conditions relating to safety and ability to retrieve all traps set. At each grid cell, the captains chose two 'lines', or set locations, in which to set 10 traps at a time. This ensured good spatial coverage of the grid cell by sampling two, more or less, different areas within one grid cell. At the first location, 10 traps were set, and then, before the second set, water clarity and temperature measurements were taken within the grid cell. After that, the second set of 10 traps was set. The goal was to have a soak time (fishing time) for each trap of 1 hour; actual soak time ranged from 45 minutes to 1.5 hour. Traps were baited with approximately 16 ounces of chopped market squid, thawed from frozen blocks. The squid was replaced with fresh bait after retrieval and prior to the next deployment of a trap.

With each trap set, location (latitude/longitude), depth, and soak time were recorded. Upon retrieval, the catch was recorded for both fish and invertebrates. Fish were processed the same as previously described; identified to species, sexed if possible, measured, and marked with a plastic t-bar tag with individual identification numbers and CCFRP contact information, as well as any comments about the fish or its condition. Fish were not tagged if in poor condition, and fish were assisted, if needed, to get back down to the bottom. Invertebrates were identified to species, sexed if possible, and color was recorded. For each grid cell, environmental conditions (swell height and direction, wind speed and direction, surface water temperature and cloud cover) were also recorded.

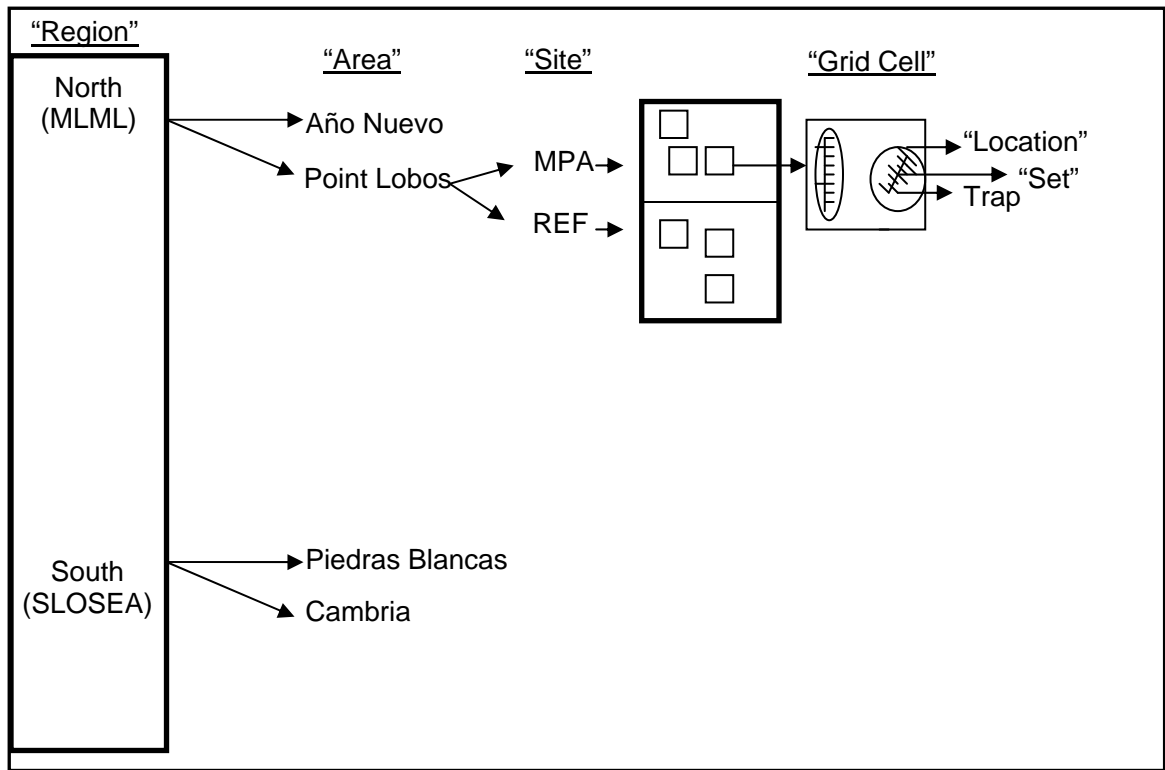

Appendix Figure 2. Terminology used to identify various levels of location information. Sampling was completed in four “Areas.” In the north, there are two areas: Año Nuevo and Point Lobos. In the south, there are two areas: Piedras Blancas and Cambria. Within each of these areas, there are two different “Sites:” either Marine Protected Area (MPA) or reference (REF). Within these sites are “Grid Cells,” which delineate the sampling boundaries. In each of the grid cells a “Set” of ten traps were completed in two distinct “locations.”

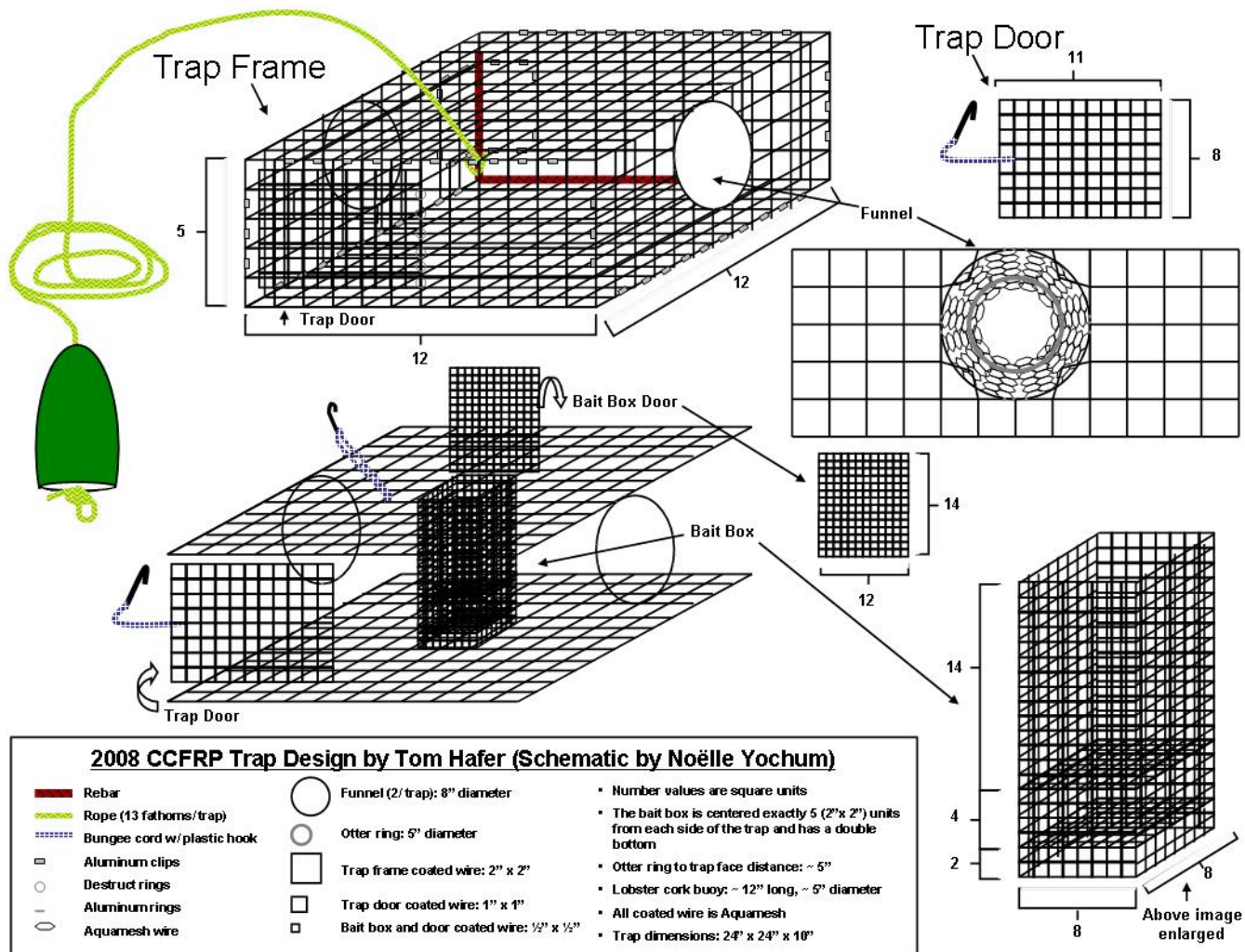

Appendix Figure 3. Schematic of research trap developed and used for CCFRP surveying 2008-2009.

Table 1. Summary of years sampled, days fished, total angler hours, and total number of fish and species caught and used in data analyses from the hook-and-line and trapping surveys.

Sample Sites Hook-Line	Years Sampled	Days Fished MPA/REF	Angler Hours MPA/REF	Fish Caught MPA/REF	Total Species MPA/REF
Año Nuevo	2007	5/6	78.4/128.8	356/919	16/17
	2008	6/6	153.4/159.9	1,032/920	16/19
	2009	4/4	85.0/117.3	732/941	19/15
	Total	15/16	316.8/406.0	2,120/2,780	22/23
Point Lobos	2007	6/6	146.5/127.6	2,923/1,254	19/18
	2008	6/6	154.5/188.9	2,331/869	18/18
	2009	4/4	80.3/67.7	700/305	15/13
	Total	16/16	381.3/384.1	5,954/2,428	21/21
Piedras Blancas	2007				
	2008	6/6	117.9/65.5	1,526/1,286	21/21
	2009	4/4	78.5/82.6	578/437	19/19
	Total	10/10	196.5/148.1	2,104/1,723	22/25
Point Buchon	2007	6/6	161.1/136.3	1,546/930	21/18
	2008	6/6	137.5/156.6	1,098/923	20/20
	2009	4/4	83.5/101.6	377/322	18/17
	Total	16/16	382.2/394.6	3,021/2,175	22/23
Grand Total	MPA/REF	57/58	578.7/542.7	13,199/9,106	31/33
Grand Total	All Areas	115	1121.4	22,305	38

Sample Sites Trap Gear	Years Sampled	Days Fished MPA/REF	Trap Hours MPA/REF	Fish Caught MPA/REF	Total Species MPA/REF
Año Nuevo	2008	6/6	256.3/295.1	105/68	8/7
	2009				
	Total	6/6	256.3/295.1	105/68	8/7
Point Lobos	2008	6/5	234.2/192.0	448/258	12/12
	2009	4/5	221.6/199.3	243/217	9/10
	Total	10/10	455.8/391.3	691/475	13/13
Cambria	2008	6/6	367.3/322.4	608/570	9/9
	2009	3/5	180.5/298.7	312/288	8/9
	Total	9/11	547.7/621.1	920/858	10/11
Piedras Blancas	2008	4/4	235.3/247.0	170/224	7/12
	2009	4/4	190.1/205.2	130/141	6/7
	Total	8/8	425.5/452.2	300/365	8/12
Grand Total	MPA/REF	33/35	1685.4/1759.8	2,016/1,766	15/18
Grand Total	All Areas	68	3445.1	3,782	18

Table 2. List of all species caught using the hook-and-line and trap gear, from all sites, areas and years combined. Values represent the percentage of the total project catch. Bold numbers represent the top ten most commonly caught species with hook-and-line gear and the top seven most commonly caught species with trap gear. An asterisk (*) indicates a value less than 0.01% when rounded.

Common Name	Scientific Name	% Total Catch (22,275 fish) Hook-and-Line	%Total Catch (3,782 fish) Trap Gear
Black rockfish	<i>Sebastes melanops</i>	11.30	
Black surfperch	<i>Embiotoca jacksoni</i>	*	
Black-and-yellow rockfish	<i>Sebastes chrysomelas</i>	0.25	17.58
Blue rockfish	<i>Sebastes mystinus</i>	33.47	0.13
Bocaccio	<i>Sebastes paucispinis</i>	0.02	
Brown rockfish	<i>Sebastes auriculatus</i>	0.69	0.16
Bull sculpin	<i>Enophrys taurina</i>	*	
Cabezon	<i>Scorpaenichthys marmoratus</i>	0.31	14.38
Calico rockfish	<i>Sebastes dalli</i>	0.03	
California halibut	<i>Paralichthys californicus</i>	*	
Canary rockfish	<i>Sebastes pinniger</i>	1.10	
China rockfish	<i>Sebastes nebulosus</i>	1.20	0.16
Copper rockfish	<i>Sebastes caurinus</i>	1.47	0.08
Gopher rockfish	<i>Sebastes carnatus</i>	30.51	55.37
Grass rockfish	<i>Sebastes rastrelliger</i>	0.05	0.69
Jacksmelt	<i>Atherinopsis californiensis</i>	0.01	
Kelp greenling	<i>Hexagrammos decagrammus</i>	0.61	8.22
Kelp rockfish	<i>Sebastes atrovirens</i>	1.32	0.74
King salmon	<i>Oncorhynchus tshawytscha</i>	*	
Lingcod	<i>Ophiodon elongatus</i>	2.13	1.61
Mackerel	<i>Scombridae spp.</i>	0.09	
Ocean whitefish	<i>Caulolatilus princeps</i>	0.05	
Olive rockfish	<i>Sebastes serranoides</i>	8.28	
Pacific bonito	<i>Sarda chiliensis</i>	*	
Pacific sardine	<i>Sardinops sagax</i>	0.01	
Painted greenling	<i>Oxylebius pictus</i>	0.01	
Rock greenling	<i>Hexagrammos lagocephalus</i>	0.03	0.08
Rock sole	<i>Lepidopsetta bilineata</i>	0.04	0.03
Rosy rockfish	<i>Sebastes rosaceus</i>	0.68	

Table 2 cont. List of all species caught using the hook-and-line and trap gear, from all sites, areas and years combined. Values represent the percentage of the total project catch. Bold numbers represent the top ten most commonly caught species with hook-and-line gear and the top seven most commonly caught species with trap gear. An asterisk (*) indicates a value less than 0.01% when rounded.

Common Name	Scientific Name	% Total Catch (22,275 fish) Hook-and-Line	%Total Catch (3,782 fish) Trap Gear
Rubberlip surfperch	<i>Hypsurus caryi</i>		0.05
Sanddab	<i>Citharichthys sordidus</i>	0.30	
Smelt	Family Osmeridae	0.01	
Starry rockfish	<i>Sebastes constellatus</i>	0.18	
Striped surfperch	<i>Embiotoca lateralis</i>		0.19
Swell shark	<i>Cephaloscyllium ventriosum</i>		0.11
Topsmelt	<i>Atherinops affinis</i>	0.01	
Treefish	<i>Sebastes serriceps</i>	0.32	0.32
Vermilion rockfish	<i>Sebastes miniatus</i>	3.37	
White croaker	<i>Genyonemus lineatus</i>	*	
Wolf eel	<i>Anarrhichthys ocellatus</i>	*	0.11
Yellowtail rockfish	<i>Sebastes flavidus</i>	2.12	

Table 3. Species composition by area, of hook-and-line catch. Values are the percentage of the total catch (numbers in parentheses) at each area for each MPA and REF site and all years combined. All totals are the combination of 2007-2009, except for Piedras Blancas, which is 2008 & 2009 combined. An asterisk (*) indicates a value less than 0.1% when rounded.

Common Name	Año Nuevo (4,900)	Point Lobos (8,356)	Piedras Blancas (3,826)	Point Buchon (5,193)	All Areas (22,275)
Black rockfish	35.4	2.9	1.2	9.6	11.3
Black surfperch			*		*
Black-and-yellow RF	0.4	*	0.1	0.6	0.2
Blue rockfish	32.9	46.4	22.6	21.2	33.5
Bocaccio			0.1		*
Brown rockfish	1.1	*	2.5		0.7
Bull sculpin			*	*	*
Cabezon	0.8	0.1	*	0.4	0.3
Calico rockfish			0.1	0.1	*
California halibut			*		*
Canary rockfish	1.2	0.9	2.4	0.5	1.1
China rockfish	2.2	1.2	0.5	0.7	1.2
Copper rockfish	0.2	1.8	3.3	0.7	1.5
Gopher rockfish	17.8	23.7	35.8	49.6	30.5
Grass rockfish	0.1	0.1			*
Jacksmelt	*			*	*
Kelp greenling	1.1	0.4	0.4	0.6	0.6
Kelp rockfish	0.1	2.7	1.1	0.5	1.3
King salmon	*				*
Lingcod	2.3	1.2	2.2	3.3	2.1
Mackerel	*	0.1	0.1	0.1	0.1
Ocean whitefish		0.1	0.1		0.1
Olive rockfish	0.4	14.3	12.0	3.4	8.3
Pacific bonito			*		*
Pacific sardine	*				*
Painted greenling	*			*	*
Rock greenling	0.1	*			*
Rock sole		*	*	0.1	*
Rosy rockfish	*	0.9	0.2	1.3	0.7
Sanddab			1.4	0.3	0.3
Smelt (Family Osmeridae)	*				*
Starry rockfish		0.1	0.2	0.5	0.2
Topsmelt	*		*		*
Treefish		*	0.1	1.2	0.3
Vermilion rockfish	1.8	1.8	10.6	2.1	3.4
White croaker	*				*
Wolf eel				*	*
Yellowtail rockfish	1.7	1.2	3.0	3.4	2.1
Total Number Species	26	23	29	25	38
Total Rockfish Species	14	16	17	15	18

Table 4. Catch composition by site and gear type at each area for the ten species most frequently caught using hook-and-line gear. Values are the percentage of the total hook-and-line catch for each species caught (Total Fish) in each site and with each gear type.

Año Nuevo 2007-2009	Total Fish	Site			Gear Type	
		%MPA	%REF	%BAR	%FLY	%BAT
Black rockfish	1,734	33.2	66.8	23.8	41.2	35.0
Blue rockfish	1,610	43.8	56.2	24.2	42.8	32.9
China rockfish	107	26.2	73.8	25.2	23.4	51.4
Copper rockfish	11	90.9	9.1	36.4	36.4	27.3
Gopher rockfish	873	58.0	42.0	25.4	28.1	46.5
Kelp rockfish	54	44.4	55.6	33.3	33.3	33.3
Lingcod	115	62.6	37.4	55.7	25.2	19.1
Olive rockfish	20	60.0	40.0	35.0	40.0	25.0
Vermilion RF	90	53.3	46.7	30.3	27.0	42.7
Yellowtail RF	84	52.4	47.6	25.0	42.9	32.1

Point Lobos 2007-2009	Total Fish	Site			Gear Type	
		%MPA	%REF	%BAR	%FLY	%BAT
Black rockfish	240	28.3	71.7	47.5	26.9	25.6
Blue rockfish	3,879	76.0	24.0	35.8	31.5	32.7
China rockfish	103	76.7	23.3	26.2	29.1	44.7
Copper rockfish	153	83.0	17.0	35.5	27.0	37.5
Gopher rockfish	1,977	62.2	37.8	25.0	28.8	46.2
Kelp rockfish	225	51.6	48.4	46.4	26.8	26.8
Lingcod	104	76.0	24.0	67.3	14.4	18.3
Olive rockfish	1,191	81.4	18.6	58.9	25.4	15.7
Vermilion RF	148	82.4	17.6	55.1	12.9	32.0
Yellowtail RF	99	52.5	47.5	44.4	37.4	18.2

Table 4 cont. Catch composition by site and gear type at each area for the ten species most frequently caught using hook-and-line gear. Values are the percentage of the total hook-and-line catch for each species caught (Total Fish) in each site and with each gear type.

Piedras Blancas 2008-2009	Total Fish	Site			Gear Type		
		%MPA	%REF	%BAR	%FLY	%BAT	
Black rockfish	45	22.2	77.8	37.8	44.4	17.8	
Blue rockfish	865	57.1	42.9	31.5	41.9	26.6	
China rockfish	19	100.0		15.8	42.1	42.1	
Copper rockfish	127	56.7	43.3	42.5	18.1	39.4	
Gopher rockfish	1,369	45.9	54.1	29.6	25.3	45.1	
Kelp rockfish	41	22.0	78.0	48.8	29.3	22.0	
Lingcod	86	57.0	43.0	66.3	15.1	18.6	
Olive rockfish	458	83.2	16.8	40.9	40.5	18.6	
Vermilion RF	406	58.1	41.9	37.7	25.9	36.5	
Yellowtail RF	114	43.9	56.1	26.5	54.0	19.5	

Point Buchon 2007-2009	Total Fish	Site			Gear Type		
		%MPA	%REF	%BAR	%FLY	%BAT	
Black rockfish	499	49.1	50.9	40.5	35.7	23.8	
Blue rockfish	1,102	67.8	32.2	30.5	38.9	30.6	
China rockfish	38	81.6	18.4	36.8	28.9	34.2	
Copper rockfish	37	48.6	51.4	24.3	32.4	43.2	
Gopher rockfish	2,576	56.3	43.7	29.1	27.8	43.1	
Kelp rockfish	25	88.0	12.0	36.0	32.0	32.0	
Lingcod	170	50.0	50.0	70.0	14.1	15.9	
Olive rockfish	175	60.6	39.4	56.6	33.1	10.3	
Vermilion RF	107	48.6	51.4	43.9	26.2	29.9	
Yellowtail RF	176	59.1	40.9	40.9	39.2	19.9	

Table 5. Catch composition by site and year for all species caught with hook-and-line gear at Año Nuevo. Values are the percentage of the total catch (numbers in parentheses) at each site: the Marine Protected Area (MPA) and reference (REF). An asterisk (*) indicates a value less than 0.1% when rounded.

Año Nuevo Common Name	2007		2008		2009		All Years	
	MPA (356)	REF (919)	MPA (1,032)	REF (920)	MPA (732)	REF (941)	MPA (2,120)	REF (2,780)
Black rockfish	33.1	46.7	27.9	39.0	23.1	39.4	27.1	41.7
Black surfperch								
Black-and-yellow RF	0.8		0.7	0.2	0.7	0.4	0.7	0.2
Blue rockfish	30.3	34.7	37.2	30.4	29.1	32.5	33.3	32.6
Bocaccio								
Brown rockfish	1.4	0.5	0.9	1.6	0.8	1.6	0.9	1.3
Bull sculpin								
Cabezon	1.1	0.1	0.2	1.6	1.0	1.2	0.6	1.0
Calico rockfish								
California halibut								
Canary rockfish	3.7	0.5	1.3	0.9	1.2	1.2	1.7	0.9
China rockfish	1.1	2.3	0.9	3.0	2.0	3.2	1.3	2.8
Copper rockfish	0.6	0.1	0.4		0.5		0.5	*
Gopher rockfish	15.7	9.5	23.4	17.6	28.6	12.5	23.9	13.2
Grass rockfish		0.1		0.1	0.4	0.1	0.1	0.1
Jacksmelt				0.2				0.1
Kelp greenling	0.6	0.5	1.3	0.9	1.2	1.8	1.1	1.1
Kelp rockfish			0.1	0.1	0.1		0.1	*
King salmon					0.1		*	
Lingcod	3.4	1.1	3.5	1.5	3.3	2.0	3.4	1.5
Mackerel		0.1		0.1				0.1
Ocean whitefish								
Olive rockfish	0.3	0.1	0.8	0.4	0.4	0.3	0.6	0.3
Pacific bonito								
Pacific sardine	0.3	0.1					*	*
Painted greenling			0.1	0.1			*	*
Rock greenling	0.6	0.1					0.1	*
Rock sole								
Rosy rockfish					0.3		0.1	
Sanddab								
Smelt				0.2				0.1
Starry rockfish								
Topsmelt						0.1		*
Treefish								
Vermilion rockfish	3.9	1.0	1.1	1.1	3.1	2.4	2.3	1.5
White croaker					0.1		*	
Wolf eel								
Yellowtail rockfish	3.1	2.4	0.5	0.8	3.8	1.2	2.1	1.4
Total Number Species	16	17	16	19	19	15	22	23
Total Rockfish Species	11	11	12	12	14	11	14	13

Table 6. Catch composition by site and year for all species caught with hook-and-line gear at Point Lobos. Values are the percentage of the total catch (numbers in parentheses) at each site: the Marine Protected Area (MPA) and reference (REF). An asterisk (*) indicates a value less than 0.1% when rounded.

Point Lobos Common Name	2007		2008		2009		All Years	
	MPA (2,917)	REF (1,235)	MPA (2,331)	REF (868)	MPA (700)	REF (305)	MPA (5,948)	REF (2,408)
Black rockfish	1.3	8.5	0.9	6.6	1.4	3.3	1.1	7.1
Black surfperch								
Black-and-yellow RF				0.2				0.1
Blue rockfish	51.1	42.3	54.9	41.6	25.7	15.4	49.6	38.6
Bocaccio								
Brown rockfish		0.1						*
Bull sculpin								
Cabezon	0.1	0.1	0.1	0.2			0.1	0.1
Calico rockfish								
California halibut								
Canary rockfish	0.6	0.6	0.8	0.5	2.3	3.0	0.9	0.8
China rockfish	1.1	0.8	1.1	1.0	3.0	1.6	1.3	1.0
Copper rockfish	2.4	0.6	1.1	1.2	4.3	2.6	2.1	1.1
Gopher rockfish	16.5	26.1	19.4	30.8	42.0	52.1	20.7	31.1
Grass rockfish	*		0.1	0.1			0.1	*
Jacksmelt								
Kelp greenling	0.5	0.5	0.3	0.6	0.6		0.4	0.5
Kelp rockfish	1.9	3.4	2.0	6.1	2.1	4.6	2.0	4.5
King salmon								
Lingcod	1.2	1.1	1.5	0.7	1.1	1.6	1.3	1.0
Mackerel	0.2	0.6					0.1	0.3
Ocean whitefish	0.1		0.1		0.6		0.1	
Olive rockfish	19.4	10.7	14.4	7.9	9.9	6.6	16.3	9.2
Pacific bonito								
Pacific sardine								
Painted greenling								
Rock greenling	*	0.2					*	0.1
Rock sole			*		0.1		*	
Rosy rockfish	0.7	1.4	0.9	0.8	1.3	0.7	0.8	1.1
Sanddab								
Smelt								
Starry rockfish	0.1	0.2		0.1		0.3	0.1	0.2
Topsmelt								
Treefish			*	0.1			*	*
Vermilion rockfish	2.2	1.5	1.7	0.2	2.9	1.6	2.1	1.1
White croaker								
Wolf eel								
Yellowtail rockfish	0.7	1.3	0.6	1.3	2.7	6.6	0.9	2.0
Total Number Species	19	18	18	18	15	13	21	21
Total Rockfish Species	13	13	13	15	11	12	14	16

Table 7. Catch composition by site and year for all species caught with hook-and-line gear at Piedras Blancas. Values are the percentage of the total catch (numbers in parentheses) at each site: the Marine Protected Area (MPA) and reference (REF). An asterisk (*) indicates a value less than 0.1% when rounded.

Piedras Blancas	2008		2009		All Years	
	MPA (1,525)	REF (1,286)	MPA (578)	REF (437)	MPA (2,103)	REF (1,723)
Common Name						
Black rockfish	0.6	2.4	0.2	0.9	0.5	2.0
Black surfperch		0.1				0.1
Black-and-yellow RF		0.1	0.3		0.1	0.1
Blue rockfish	27.2	27.8	13.7	3.0	23.5	21.5
Bocaccio	0.3				0.2	
Brown rockfish	0.5	5.1	3.5	0.9	1.3	4.0
Bull sculpin						0.1
Cabazon	0.1				*	
Calico rockfish	0.1			0.2	0.1	0.1
California halibut				0.2		0.1
Canary rockfish	2.0	2.0	5.7	0.5	3.0	1.6
China rockfish	1.1		0.3		0.9	
Copper rockfish	2.4	2.3	6.2	5.9	3.4	3.2
Gopher rockfish	30.6	38.7	28.0	55.6	29.9	43.0
Grass rockfish						
Jacksmelt						
Kelp greenling	0.3	0.3	0.7	0.5	0.4	0.3
Kelp rockfish	0.3	1.8	0.7	2.1	0.4	1.9
King salmon						
Lingcod	2.4	1.7	2.2	3.4	2.3	2.1
Mackerel		0.2				0.1
Ocean whitefish	0.1		0.3		0.2	
Olive rockfish	19.8	5.3	13.7	2.1	18.1	4.5
Pacific bonito		0.1				0.1
Pacific sardine						
Painted greenling						
Rock greenling						
Rock sole				0.2		0.1
Rosy rockfish	0.2	0.2	0.3	0.2	0.2	0.2
Sanddab	1.2	0.5	2.6	2.7	1.6	1.1
Smelt						
Starry rockfish	0.1	0.1	0.2	0.7	0.1	0.2
Topsmelt		0.1				0.1
Treefish	0.1	0.2	0.2	0.2	0.1	0.2
Vermilion rockfish	8.7	7.9	17.8	15.8	11.2	9.9
White croaker						
Wolf eel						
Yellowtail rockfish	2.0	3.3	3.3	4.8	2.4	3.7
Total Number Species	21	21	19	19	22	25
Total Rockfish Species	16	14	15	14	17	15

Table 8. Catch composition by site and year for all species caught with hook-and-line gear at Point Buchon. Values are the percentage of the total catch (numbers in parentheses) at each site: the Marine Protected Area (MPA) and reference (REF). An asterisk (*) indicates a value less than 0.1% when rounded.

Point Buchon Common Name	2007		2008		2009		All Years	
	MPA (1,546)	REF (929)	MPA (1,097)	REF (922)	MPA (377)	REF (322)	MPA (3,020)	REF (2,173)
Black rockfish	5.7	10.5	10.0	14.1	12.5	8.1	8.1	11.7
Black surfperch								
Black-and-yellow RF	0.1	1.4	0.2	0.3	0.5	2.2	0.2	1.1
Blue rockfish	28.8	14.7	25.7	19.6	5.3	11.5	24.7	16.3
Bocaccio								
Brown rockfish								
Bull sculpin						0.3		*
Cabezon	0.2	0.8	0.3	0.2	0.8	0.3	0.3	0.5
Calico rockfish	0.1			0.2		0.3	*	0.1
California halibut								
Canary rockfish	0.7	0.1	0.7	0.3		0.3	0.6	0.2
China rockfish	1.0	0.3	0.7	0.4	1.9		1.0	0.3
Copper rockfish	0.6	0.4	0.5	1.4	0.8	0.6	0.6	0.9
Gopher rockfish	46.1	51.6	48.6	52.3	54.6	50.9	48.0	51.8
Grass rockfish								
Jacksmelt				0.1				*
Kelp greenling	0.2	2.4	0.3	0.2	0.3		0.2	1.1
Kelp rockfish	0.6	0.2	0.4	0.1	2.1		0.7	0.1
King salmon								
Lingcod	1.8	3.8	2.8	3.6	6.9	5.3	2.8	3.9
Mackerel	0.1		0.0	0.2			*	0.1
Ocean whitefish								
Olive rockfish	4.3	6.2	2.3	1.2	4.0		3.5	3.2
Pacific bonito								
Pacific sardine								
Painted greenling						0.3		*
Rock greenling								
Rock sole	0.1	0.1	0.1			0.6	0.1	0.1
Rosy rockfish	2.1	0.4	1.4	0.5	1.1	1.9	1.7	0.7
Sanddab	0.2		0.8		0.5		0.5	
Smelt								
Starry rockfish	0.9	0.2	0.3	0.1	0.5	0.9	0.6	0.3
Topsmelt								
Treefish	0.9	1.9	1.0	1.0	1.1	2.5	1.0	1.6
Vermilion rockfish	1.6	2.3	2.4	2.6	0.5	3.1	1.7	2.5
White croaker								
Wolf eel					0.3		*	
Yellowtail rockfish	4.0	2.6	1.6	1.4	6.4	10.9	3.4	3.3
Total Number Species	21	18	20	20	18	17	22	23
Total Rockfish Species	15	14	14	15	13	12	15	15

Table 9. Comparison of similarity of species composition among MPAs. Values represent the percent similarity of species composition among all MPAs surveyed. The shaded boxes represent the percent similarity between a marine protected area and its reference site.

	Año Nuevo	Point Lobos	Piedras Blancas	Point Buchon
Año Nuevo	(MPA/REF 83.4)			
Point Lobos	63.7	(MPA/REF 79.2)		
Piedras Blancas	62	70.4	(MPA/REF 80.6)	
Point Buchon	69.2	58.2	67.6	(MPA/REF 87.6)

Table 10. Catch composition by site and year for all species caught with different types of hook-and-line gear for all areas combined. Values are the percentage of the total catch for all years combined (numbers in parentheses) for each gear type: lingcod bars (BAR), unbaited shrimp flies (FLY), and shrimp flies with squid bait (BAIT). All gear types were fished with equal effort. An asterisk (*) indicates a value less than 0.1% when rounded.

	BAR (7,458)	FLY (7,088)	BAIT (7,683)
Black rockfish	10.0	13.8	10.3
Black surfperch	*		
Black-and-yellow RF	0.2	0.2	0.3
Blue rockfish	32.0	38.1	30.7
Bocaccio	*	*	
Brown rockfish	0.6	0.5	0.9
Bull sculpin	*		
Cabazon	0.5	0.2	0.2
Calico rockfish	*	*	*
California halibut	*		
Canary rockfish	1.0	1.1	1.2
China rockfish	1.0	1.0	1.6
Copper rockfish	1.6	1.1	1.6
Gopher rockfish	25.0	26.4	39.6
Grass rockfish	0.1	*	*
Jacksmelt	*	*	*
Kelp greenling	0.9	0.3	0.6
Kelp rockfish	1.8	1.1	1.0
King salmon	*		
Lingcod	4.2	1.1	1.1
Mackerel	0.1	0.1	0.1
Ocean whitefish	*	0.1	0.1
Olive rockfish	13.3	7.8	3.8
Pacific bonito	*		
Pacific sardine	*		
Painted greenling	*		
Rock greenling	*	*	*
Rock sole	*	*	0.1
Rosy rockfish	0.4	0.8	0.8
Sanddab	0.3	0.2	0.5
Smelt	*		
Starry rockfish	0.1	0.1	0.3
Topsmelt	*	*	
Treefish	0.3	0.4	0.3
Vermilion rockfish	4.1	2.5	3.4
White croaker	*		*
Wolf eel	*		*
Yellowtail rockfish	2.2	2.9	1.3
All Species Combined (%)	33.6	31.9	34.6
Total Number Species	36	28	28
Total Rockfish Species	18	18	17

Table 11. Catch composition by hook-and-line gear type at each area. Values are the percentage of the total catch for all years combined (numbers in parentheses) for each gear type: lingcod bars (BAR), unbaited shrimp flies (FLY), and shrimp flies with squid bait (BAIT). All gear were fished with equal effort. An asterisk (*) indicates a value less than 0.1% when rounded.

Common Name	Año Nuevo			Point Lobos			Piedras Blancas			Point Buchon		
	BAR (1,268)	FLY (1,836)	BAIT (1,790)	BAR (3,147)	FLY (2,428)	BAIT (2,754)	BAR (1,302)	FLY (1,203)	BAIT (1,315)	BAR (1,741)	FLY (1,621)	BAIT (1,824)
Black rockfish	32.6	38.9	33.9	3.6	2.6	2.2	1.3	1.7	0.6	11.6	11.0	6.5
Black surfperch							0.1					
Black-and-yellow RF	0.5	0.3	0.6	*	*		0.1		0.2	0.4	0.7	0.6
Blue rockfish	30.7	37.5	29.6	44.0	50.2	45.9	20.9	30.1	17.5	19.3	26.4	18.5
Bocaccio							0.2	0.2				
Brown RF	1.3	0.7	1.5			*	2.5	2.0	3.1			
Bull sculpin										0.1		
Cabezón	1.7	0.5	0.5	0.1	0.1	0.1	0.1			0.6	0.2	0.2
Calico RF							0.1	0.1	0.1		0.1	0.1
CA halibut							0.1					
Canary RF	1.0	1.3	1.3	0.8	0.9	0.9	2.8	2.0	2.4	0.1	0.6	0.7
China rockfish	2.1	1.4	3.1	0.9	1.2	1.7	0.2	0.7	0.6	0.8	0.7	0.7
Copper RF	0.3	0.2	0.2	1.7	1.7	2.1	4.1	1.9	3.8	0.5	0.7	0.9
Gopher RF	17.5	13.3	22.7	15.6	23.4	33.0	31.1	28.7	46.8	43.0	44.0	60.7
Grass rockfish	0.2	0.2	0.1	0.1		*						
Kelp greenling	2.1	0.3	1.2	0.5	0.3	0.5	0.5	0.3	0.2	1.2	0.2	0.4
Kelp rockfish	0.1	0.1	0.1	3.3	2.5	2.2	1.5	1.0	0.7	0.5	0.5	0.4
King salmon	0.1											
Lingcod	5.0	1.6	1.2	2.2	0.6	0.7	4.4	1.1	1.2	6.8	1.5	1.5
Mackerel		0.1	0.1	0.1		0.3	0.2				0.2	
Ocean whitefish				*	0.2	0.1			0.3			
Olive rockfish	0.6	0.4	0.3	22.2	12.4	6.8	14.4	15.4	6.5	5.7	3.6	1.0
Pacific bonito							0.1					
Pacific sardine	0.1	0.1										
Painted greenling	0.2									0.1		

Table 11 cont. Catch composition by hook-and-line gear type at each area. Values are the percentage of the total catch for all years combined (numbers in parentheses) for each gear type: lingcod bars (BAR), unbaited shrimp flies (FLY), and shrimp flies with squid bait (BAIT). All gear were fished with equal effort. An asterisk (*) indicates a value less than 0.1% when rounded.

Common Name	Año Nuevo			Point Lobos			Piedras Blancas			Point Buchon		
	BAR (1,268)	FLY (1,836)	BAIT (1,790)	BAR (3,147)	FLY (2,428)	BAIT (2,754)	BAR (1,302)	FLY (1,203)	BAIT (1,315)	BAR (1,741)	FLY (1,621)	BAIT (1,824)
Rock greenling			0.2	0.1	0.1							
Rock sole					0.1			0.1		0.1		0.2
Rosy rockfish			0.1	0.7	1.1	1.0	0.2	0.2	0.2	0.5	1.6	1.7
Sanddab							1.0	0.7	2.4	0.3	0.2	0.3
Smelt	0.2	0.1	0.1					0.1		0.1		
Starry rockfish				0.1	0.1	0.1	0.2	0.1	0.2	0.4	0.3	0.7
Treefish					0.1		0.1		0.3	1.1	1.5	1.2
Vermilion RF	2.1	1.3	2.1	2.6	0.8	1.7	11.8	8.7	11.3	2.7	1.7	1.8
White croaker			0.1									
Wolf eel												0.1
Yellowtail RF	1.7	2.0	1.5	1.4	1.5	0.7	2.3	5.1	1.7	4.1	4.3	1.9
Total Species	20	19	21	20	20	19	25	20	20	22	20	21
Total Rockfish	13	13	14	14	14	14	17	15	16	14	15	15

Table 12. Species catch composition from trap gear, by area. Values are the percentage of the total catch (numbers in parentheses) at each area for sites (MPA and REF) and years combined. The top seven most commonly caught species are indicated with asterisks (*).

Common Name	Año Nuevo 2008 (173)	Point Lobos 2008 & 2009 (1,166)	Piedras Blancas 2008 & 2009 (665)	Cambria 2008 & 2009 (1,778)
Black-and-yellow rockfish	14.5	14.1	18.8	19.7
Blue rockfish		0.2	0.2	0.1
Brown rockfish			0.9	
Cabazon	30.6	11.1	18.6	13.4
China rockfish	0.6	0.3		0.1
Copper rockfish		0.1	0.3	
Gopher rockfish	26.6	58.4	46.8	59.4
Grass rockfish	2.3	0.5	0.3	0.8
Kelp greenling	17.3	11.3	10.5	4.4
Kelp rockfish		0.6	1.1	0.8
Lingcod	4.6	2.3	1.8	0.8
Rainbow surfperch		0.1		0.1
Rock greenling		0.3		
Rubberlip surfperch			0.2	
Striped surfperch	2.9	0.2		
Swell shark			0.3	0.1
Treefish		0.5	0.2	0.3
Wolf eel	0.6	0.1	0.2	0.1
Total Number Species	9	15	14	13
Total Number Rockfishes	4	8	8	7

Table 13. Species composition of fishes caught with trap gear by site and year at Año Nuevo, Point Lobos, Cambria, and Piedras Blancas. Values are the percentage of the total catch (numbers in parentheses) at each site: the Marine Protected Area (MPA) and reference (REF).

Common Name	Año Nuevo 2008		Point Lobos 2008		Point Lobos 2009		Point Lobos All Years	
	MPA (105)	REF (68)	MPA (448)	REF (258)	MPA (243)	REF (217)	MPA (691)	REF (475)
Black-and-yellow rockfish	13.3	16.2	10.0	14.0	21.0	14.7	13.9	14.3
Blue rockfish			0.2			0.5	0.1	0.2
Brown rockfish								
Cabezon	20.0	47.1	12.3	12.4	8.2	10.1	10.9	11.4
China rockfish		1.5	0.2	0.4	0.4	0.5	0.3	0.4
Copper rockfish					0.4		0.1	
Gopher rockfish	39.0	7.4	64.7	46.9	57.2	60.4	62.1	53.1
Grass rockfish	1.0	4.4	0.2	0.8		1.4	0.1	1.1
Kelp greenling	15.2	20.6	7.8	20.5	9.9	9.2	8.5	15.4
Kelp rockfish			0.4	1.6	0.4		0.4	0.8
Lingcod	5.7	2.9	3.3	1.6	1.6	1.8	2.7	1.7
Rainbow surfperch			0.2				0.1	
Rock greenling				0.4		0.9		0.6
Rubberlip surfperch								
Striped surfperch	4.8		0.2	0.4			0.1	0.2
Swell shark								
Treefish			0.2	0.8	0.8	0.5	0.4	0.6
Wolf eel	1.0			0.4				0.2
Total Number Species	8	7	12	12	9	10	13	13
Total Rockfishes	3	4	7	6	6	6	8	7

Table 13 cont. Species composition of fishes caught with trap gear by site and year at Año Nuevo, Point Lobos, Cambria, and Piedras Blancas. Values are the percentage of the total catch (numbers in parentheses) at each site: the Marine Protected Area (MPA) and reference (REF).

Common Name	Piedras Blancas 2008		Piedras Blancas 2009		Piedras Blancas All Years		Cambria 2008		Cambria 2009		Cambria All Years	
	MPA (170)	REF (224)	MPA (130)	REF (141)	MPA (300)	REF (365)	MPA (608)	REF (570)	MPA (312)	REF (288)	MPA (920)	REF (858)
Black and Yellow RF	19.4	15.2	30.8	12.8	24.3	14.2	18.1	24.4	17.3	16.7	17.8	21.8
Blue Rockfish	0.6				0.3				0.7		0.2	
Brown Rockfish		1.8		1.4		1.6						
Cabazon	32.9	9.8	25.4	9.2	29.7	9.6	14.1	10.5	17.0	13.5	15.1	11.5
China Rockfish									0.3		0.1	
Copper Rockfish		0.4		0.7		0.5						
Gopher Rockfish	34.7	57.6	25.4	63.8	30.7	60.0	60.2	58.8	54.5	64.2	58.3	60.6
Grass Rockfish		0.9				0.5	1.0	0.9	1.0		1.0	0.6
Kelp Greenling	8.8	8.0	16.2	11.3	12.0	9.3	4.1	3.5	7.7	3.5	5.3	3.5
Kelp Rockfish	0.6	2.7			0.3	1.6	1.0	0.9	1.0		1.0	0.6
Lingcod	2.9	1.8	1.5	0.7	2.3	1.4	1.0	0.7	1.0	0.3	1.0	0.6
Rainbow seaperch								0.2				0.1
Rock Greenling												
Rubberlip seaperch		0.4				0.3						
Striped seaperch												
Swell Shark		0.9				0.5			0.6		0.2	
Treefish		0.4				0.3	0.3	0.2		0.7	0.2	0.3
Wolf Eel			0.8		0.3		0.2				0.1	
Total Species	7	12	6	7	8	12	9	9	8	8	10	11
Total Rockfish	4	7	2	4	4	7	5	5	4	5	5	7

Table 14. Invertebrate catches from trap gear at all areas and sites, for A) 2008 and B) 2009.

A)									
2008	Ano Nuevo		Point Lobos		Cambria		Piedras Blancas		Total
Species	MPA	REF	MPA	REF	MPA	REF	MPA	REF	
Bat star	107	74	162	83	197	264	133	115	1135
<i>Asterina miniata</i>									
Black turban snail									
<i>Tegula funebris</i>									
Blood star			1						1
<i>Henricia leviuscula</i>									
Brown rock crab	39	63	26	41	51	56	88	37	401
<i>Cancer antennarius</i>									
Cryptic kelp crab	1								1
<i>Pugettia richii</i>									
Dungeness crab	2	1							3
<i>Cancer magister</i>									
Dusky turban snail									
<i>Tegula pulligo</i>									
Giant pink star	5	11			3		1	5	25
<i>Pisaster brevispinus</i>									
Giant spined star	4	1	13	5	2	7		1	33
<i>Pisaster giganteus</i>									
Gumboot chiton									
<i>Cryptochiton stelleri</i>									
Leather star			1	2			1	3	7
<i>Dermasterias imbricata</i>									
<i>Loxorhynchus</i> spp.	27	7	50	9	2	9	23	49	176
Northern kelp crab	1		1		1				3
<i>Pugettia producta</i>									
<i>Pugettia</i> spp.									
Purple-ringed top snail									
<i>Calliostoma annulatum</i>									
Rainbow star									
<i>Orthasterias koehleri</i>									
Red rock crab	24	23	8	2	5	10	7	14	93
<i>Cancer productus</i>									
Six-arm star									
<i>Lepasterias hexactis</i>									
Slender crab									
<i>Cancer gracilis</i>									
Spiny sand star							1		1
<i>Astropecten armatus</i>									
Sunflower star	86	107	32	51	126	113	82	131	728
<i>Pycnopodia helianthoides</i>									

Table 14 cont. Invertebrate catches from trap gear at all areas and sites, for A) 2008 and B) 2009.

B)							
2009	Point Lobos		Cambria		Piedras Blancas		Total
Species	MPA	REF	MPA	REF	MPA	REF	
Bat star	157	124	96	125	145	125	772
<i>Asterina miniata</i>							
Black turban snail	2						2
<i>Tegula funebris</i>							
Blood star							
<i>Henricia leviuscula</i>							
Brown rock crab	22	28	72	59	38	26	245
<i>Cancer antennarius</i>							
Cryptic kelp crab							
<i>Pugettia richii</i>							
Dungeness crab				1			1
<i>Cancer magister</i>							
Dusky turban snail	1						1
<i>Tegula pulligo</i>							
Giant pink star						4	4
<i>Pisaster brevispinus</i>							
Giant spined star	8	13	4		1		26
<i>Pisaster giganteus</i>							
Gumboot chiton	1	1					2
<i>Cryptochiton stelleri</i>							
Leather star	2	2				1	5
<i>Dermasterias imbricata</i>							
<i>Loxorhynchus</i> spp.	14	21	1	4	1	28	69
Northern kelp crab	2	1	1	1	2	12	19
<i>Pugettia producta</i>							
<i>Pugettia</i> spp.							
Purple-ringed top snail	1						1
<i>Calliostoma annulatum</i>							
Rainbow star	2						2
<i>Orthasterias koehleri</i>							
Red rock crab	1	2	4	5	6	13	31
<i>Cancer productus</i>							
Six-arm star		1					1
<i>Lepasterias hexactis</i>							
Slender crab				2			2
<i>Cancer gracilis</i>							
Spiny sand star							
<i>Astropecten armatus</i>							
Sunflower star	46	50	72	84	77	79	408
<i>Pycnopodia helianthoides</i>							

Table 15. Average catch per angler hour values with standard error (SE) for all species combined by area (Año Nuevo (AN), Point Lobos (PL), Piedras Blancas (BL), and Point Buchon (PB)) and site (Marine Protected Area (MPA) and reference (REF)). No values are listed for Piedras Blancas (BL) in 2007 as samples were not collected at this area for that year.

		Catch per Angler Hour (SE)			
		All years combined	2007	2008	2009
	AN	6.3 (0.3)	5.6 (0.5)	5.9 (0.4)	7.9 (0.6)
	AN MPA	6.2 (0.4)	4.4 (0.6)	6.5 (0.6)	8.0 (1.0)
	AN REF	6.4 (0.4)	6.5 (0.8)	5.4 (0.7)	7.9 (0.9)
	PL	10.5 (0.8)	15.1 (1.6)	9.5 (1.0)	5.2 (0.6)
	PL MPA	14.8 (1.2)	19.7 (2.5)	14.8 (1.1)	7.2 (0.9)
	PL REF	6.2 (0.7)	10.1 (1.6)	4.4 (0.6)	3.1 (0.5)
	BL	6.5 (0.6)		7.2 (0.7)	5.8 (0.9)
	BL MPA	7.6 (0.9)		8.3 (1.0)	6.7 (1.6)
	BL REF	5.2 (0.5)		5.5 (0.8)	4.9 (0.6)
	PB	6.2 (0.3)	7.2 (0.5)	6.7 (0.5)	3.6 (0.3)
	PB MPA	7.6 (0.5)	9.2 (0.8)	8.1 (0.7)	4.1 (0.3)
	PB REF	4.8 (0.3)	5.3 (0.4)	5.3 (0.5)	3.2 (0.4)

Table 16. The average catch per angler hour (CPUE) and standard error (SE) for each species by area (Año Nuevo (AN), Point Lobos (PL), Piedras Blancas (BL), and Point Buchon (PB)) and site (Marine Protected Area (MPA) and reference (REF)) for all years combined. An asterisk (*) indicates values less than 0.01 when rounded.

Species Code	AN	AN MPA	AN REF	PL	PL MPA	PL REF
Black rockfish	2.2 (0.2)	1.7 (0.2)	2.7 (0.2)	0.4 (0.1)	0.2 (0.04)	0.6 (0.2)
Blue rockfish	2.0 (0.2)	2.0 (0.3)	2.1 (0.2)	4.9 (0.5)	7.3 (0.9)	2.3 (0.4)
China rockfish	0.1 (0.02)	0.09 (0.02)	0.2 (0.03)	0.1 (0.02)	0.2 (0.03)	0.07 (0.03)
Copper rockfish	1.1 (0.01)	0.03 (0.01)	* (*)	0.2 (0.03)	0.3 (0.05)	0.06 (0.01)
Gopher rockfish	1.1 (0.09)	1.5 (0.1)	0.9 (0.08)	2.4 (0.1)	2.9 (0.2)	1.8 (0.2)
Kelp rockfish	0.01 (*)	0.01 (0.01)	* (*)	0.3 (0.03)	0.3 (0.04)	0.2 (0.04)
Lingcod	0.1 (0.02)	0.2 (0.03)	0.1 (0.02)	0.1 (0.02)	0.2 (0.03)	0.06 (0.01)
Olive rockfish	0.02 (0.01)	0.03 (0.01)	0.01 (0.01)	1.5 (0.2)	2.5 (0.4)	0.5 (0.08)
Vermilion rockfish	0.1 (0.02)	0.1 (0.04)	0.1 (0.02)	0.2 (0.03)	0.3 (0.05)	0.07 (0.02)
Yellowtail rockfish	0.1 (0.03)	0.2 (0.06)	0.1 (0.03)	0.1 (0.02)	0.1 (0.03)	0.1 (0.03)

Species Code	BL	BL MPA	BL REF	PB	PB MPA	PB REF
Black rockfish	0.05 (0.02)	0.04 (0.02)	0.07 (0.04)	0.6 (0.07)	0.7 (0.1)	0.5 (0.09)
Blue rockfish	1.3 (0.2)	1.7 (0.4)	0.8 (0.2)	1.3 (0.1)	1.9 (0.3)	0.8 (0.1)
China rockfish	0.02 (0.01)	0.04 (0.01)	0 (0)	0.05 (0.01)	0.08 (0.02)	0.01 (0.01)
Copper rockfish	0.3 (0.03)	0.3 (0.05)	0.2 (0.05)	0.04 (0.01)	0.04 (0.01)	0.04 (0.01)
Gopher rockfish	2.3 (0.2)	2.3 (0.3)	2.4 (0.3)	3.1 (0.2)	3.6 (0.3)	2.6 (0.2)
Kelp rockfish	0.2 (0.05)	0.03 (0.01)	0.3 (0.1)	0.03 (0.01)	0.06 (0.02)	0.01 (0.01)
Lingcod	0.1 (0.02)	0.1 (0.03)	0.1 (0.03)	0.2 (0.02)	0.2 (0.03)	0.2 (0.03)
Olive rockfish	0.8 (0.1)	1.3 (0.2)	0.1 (0.05)	0.2 (0.03)	0.3 (0.04)	0.1 (0.03)
Vermilion rockfish	0.8 (0.1)	0.9 (0.2)	0.6 (0.1)	0.1 (0.02)	0.1 (0.03)	0.1 (0.02)
Yellowtail rockfish	0.2 (0.05)	0.2 (0.07)	0.2 (0.08)	0.2 (0.03)	0.2 (0.05)	0.1 (0.04)

Table 17. Mean catch per angler hour per day (CPUE) of hook-and-line sampling gear and the number of days of sampling needed to yield a coefficient of variance (CV) ≤ 0.5 and ≤ 0.25 . Values were derived using Resampling Stats 6.0 to mimic sampling from 1 to 20 days at 50,000 iterations each from actual data collected in the Año Nuevo (AN), Point Lobos (PL), Piedras Blancas (PB), and Point Buchon (PB) MPAs. CPUE values are the sum of all drifts in a cell and all cells fished in one day (~4).

Species	AN			PL		
	mean CPUE	# days to CV ≤ 0.5	# days to CV ≤ 0.25	mean CPUE	# days to CV ≤ 0.5	# days to CV ≤ 0.25
Black rockfish	1.70	2	5	1.80	4	15
Blue rockfish	2.00	2	7	7.50	2	6
China rockfish	0.09	7	< 20	0.18	3	12
Copper rockfish	0.03	6	< 20	0.35	3	10
Gopher rockfish	1.40	2	6	2.90	1	2
Kelp rockfish	1.40	2	6	0.27	2	7
Lingcod	0.18	3	9	0.20	3	9
Olive rockfish	0.03	20	< 20	2.52	3	12
Vermilion rockfish	0.15	5	16	0.33	2	6
Yellowtail rockfish	0.15	6	< 20	0.12	4	15

Table 17 cont. Mean catch per angler hour per day (CPUE) of hook-and-line sampling gear and the number of days of sampling needed to yield a coefficient of variance (CV) ≤ 0.5 and ≤ 0.25 . Values were derived using Resampling Stats 6.0 to mimic sampling from 1 to 20 days at 50,000 iterations each from actual data collected in the Año Nuevo (AN), Point Lobos (PL), Piedras Blancas (PB), and Point Buchon (PB) MPAs. CPUE values are the sum of all drifts in a cell and all cells fished in one day (~4).

Species	BL			PB		
	mean CPUE	# days to CV ≤ 0.5	# days to CV ≤ 0.25	mean CPUE	# days to CV ≤ 0.5	# days to CV ≤ 0.25
Black rockfish	0.06	16	< 20	0.62	2	5
Blue rockfish	2.13	3	10	1.83	3	13
China rockfish	0.04	5	17	0.08	4	13
Copper rockfish	0.31	2	5	0.04	5	19
Gopher rockfish	2.38	1	3	3.56	1	3
Kelp rockfish	0.03	5	19	0.06	4	15
Lingcod	0.15	3	9	0.15	3	10
Olive rockfish	1.33	2	7	0.26	2	6
Vermilion rockfish	0.93	2	8	0.13	3	10
Yellowtail rockfish	0.21	6	< 20	0.26	2	6

Table 18. Average catch per trap hour values (standard error) with all species combined by area (Año Nuevo (AN), Point Lobos (PL), Piedras Blancas (BL), and Cambria (CA)) and site (Marine Protected Area (MPA) and reference (REF)). No values are listed for 2007 as the trap study was only conducted in 2008 and 2009.

		Catch per Trap Hour (SE)		
		All years Combined	2008	2009
	AN	0.3 (0.05)	0.3 (0.05)	
	AN MPA	0.4 (0.1)	0.4 (0.1)	
	AN REF	0.2 (0.1)	0.2 (0.1)	
	PL	1.4 (0.1)	1.8 (0.2)	1.0 (0.1)
	PL MPA	1.6 (0.2)	2.0 (0.3)	1.0 (0.1)
	PL REF	1.1 (0.1)	1.3 (0.2)	1.0 (0.1)
	BL	0.8 (0.1)	0.8 (0.1)	0.7 (0.1)
	BL MPA	0.6 (0.1)	0.7 (0.1)	0.6 (0.1)
	BL REF	0.8 (0.1)	0.9 (0.1)	0.7 (0.1)
	CA	1.6 (0.1)	1.7 (0.2)	1.3 (0.2)
	CA MPA	1.7 (0.2)	1.9 (0.3)	1.4 (0.4)
	CA REF	1.5 (0.1)	1.6 (0.2)	1.3 (0.2)

Table 19. The average annual catch per trap hour (CPUE) and standard error (SE) for each species by area (Año Nuevo (AN), Point Lobos (PL), Piedras Blancas (BL), and Cambria (CA)), by Marine Protected Area (MPA) and reference (REF) sites for all years combined. An asterisk (*) indicates values less than 0.01 when rounded.

Species	AN	AN MPA	AN REF	PL	PL MPA	PL REF
Black-and-yellow rockfish	0.05 (0.02)	0.06 (0.03)	0.04 (0.01)	0.2 (0.03)	0.2 (0.04)	0.2 (0.03)
Cabezon	0.1 (0.02)	0.09 (0.02)	0.01 (0.03)	0.2 (0.03)	0.2 (0.03)	0.2 (0.05)
Gopher rockfish	0.1 (0.02)	0.2 (0.01)	0.02 (0.01)	0.8 (0.1)	1.0 (0.1)	0.6 (0.1)
Grass rockfish	0.01 (0.02)	0.01 (0.01)	0.01 (0.01)	0.01 (*)	* (*)	0.01 (*)
Kelp greenling	0.06 (0.02)	0.1 (0.035)	0.04 (0.01)	0.2 (0.02)	0.1 (0.02)	0.2 (0.03)
Lingcod	0.01 (0.01)	0.02 (0.01)	0.08 (0.01)	0.04 (0.01)	0.05 (0.02)	0.02 (0.01)
Treefish	0 (0)	0 (0)	0 (0)	0.01 (*)	0.01 (*)	* (*)

Species	BL	BL MPA	BL REF	CA	CA MPA	CA REF
Black-and-yellow rockfish	0.1 (0.02)	0.2 (0.03)	0.1 (0.03)	0.4 (0.04)	0.3 (0.04)	0.4 (0.07)
Cabezon	0.1 (0.02)	0.2 (0.04)	0.06 (0.01)	0.2 (0.03)	0.3 (0.04)	0.2 (0.03)
Gopher rockfish	0.4 (0.07)	0.2 (0.05)	0.5 (0.1)	1.0 (0.2)	1.1 (0.3)	0.8 (0.1)
Grass rockfish	* (*)	0 (0)	* (*)	0.01 (0.01)	0.01 (*)	0.01 (0.01)
Kelp greenling	0.06 (0.01)	0.07 (0.02)	0.06 (0.01)	0.06 (0.01)	0.07 (0.02)	0.05 (0.01)
Lingcod	0.01 (*)	0.01 (*)	0.01 (*)	0.01 (*)	0.02 (*)	0.01 (*)
Treefish	* (*)	0 (0)	* (*)	* (*)	* (*)	* (*)

Table 20. Mean catch per day (CPUE) of trap sampling and number of sampling days needed to yield a coefficient of variance (CV) ≤ 0.5 and ≤ 0.25 . Values were derived using Resampling Stats 6.0 to mimic sampling from 1 to 20 days at 50,000 iterations each from actual data collected in the Año Nuevo (AN), Point Lobos (PL), Piedras Blancas (BL), and Cambria (CA) MPAs. Catch per day values for the trap study are the sum of all traps set in one day (10-61 traps/day). An asterisk (*) represents incalculable CV values resulting from too many zeros in the dataset.

Species	AN			PL		
	mean CPUE	# days to CV ≤ 0.5	# days to CV ≤ 0.25	mean CPUE	# days to CV ≤ 0.5	# days to CV ≤ 0.25
Black-and-yellow rockfish	0.05	6	< 20	0.21	1	4
Cabazon	0.09	2	7	0.18	4	12
Gopher rockfish	0.17	1	4	0.90	2	6
Grass rockfish	0.003	20	< 20	0.005	< 20	< 20
Kelp greenling	0.06	4	14	0.16	4	13
Lingcod	0.02	6	< 20	0.04	4	16
Treefish	*	*	*	0.005	18	< 20

Species	BL			CA		
	mean CPUE	# days to CV ≤ 0.5	# days to CV ≤ 0.25	mean CPUE	# days to CV ≤ 0.5	# days to CV ≤ 0.25
Black-and-yellow rockfish	0.18	1	3	0.28	< 1	1
Cabazon	0.21	2	6	0.24	1	4
Gopher rockfish	0.20	3	11	0.79	5	20
Grass rockfish	*	*	*	0.02	4	15
Kelp greenling	0.10	3	9	0.08	1	4
Lingcod	0.01	5	17	0.01	4	17
Treefish	*	*	*	*	*	*

Table 21. Average biomass (kg) caught per angler hour values with standard error (SE) of the ten most frequently caught species using hook-and-line gear combined by area (Año Nuevo (AN), Point Lobos (PL), Piedras Blancas (BL), and Point Buchon (PB)) and site (Marine Protected Area (MPA) and reference (REF)). No values are listed for Piedras Blancas (BL) in 2007, as samples were not collected at this area for that year.

		kg per Angler Hour (SE)			
		All Years Combined	2007	2008	2009
	AN	3.0 (0.1)	2.5 (0.2)	3.0 (0.2)	3.7 (0.3)
	AN MPA	3.1 (0.2)	2.1 (0.4)	3.3 (0.3)	3.9 (0.5)
	AN REF	2.9 (0.2)	2.7 (0.3)	2.7 (0.4)	3.5 (0.3)
	PL	5.1 (0.4)	7.2 (0.9)	4.6 (0.5)	2.5 (0.3)
	PL MPA	7.5 (0.7)	10.0 (1.4)	7.6 (0.6)	3.5 (0.4)
	PL REF	2.6 (0.3)	4.0 (0.6)	1.8 (0.3)	1.5 (0.2)
	BL	3.8 (0.3)		3.9 (0.5)	3.6 (0.5)
	BL MPA	5.0 (0.5)		5.1 (0.6)	4.9 (0.8)
	BL REF	2.5 (0.3)		2.5 (0.4)	2.5 (0.3)
	PB	2.6 (0.1)	2.7 (0.2)	3.0 (0.2)	1.8 (0.1)
	PB MPA	3.1 (0.2)	3.4 (0.3)	3.5 (0.3)	2.1 (0.2)
	PB REF	2.1 (0.1)	2.1 (0.2)	2.6 (0.3)	1.5 (0.2)

Table 22. The average biomass in kilograms per angler hour (BPUE) and standard error (SE) for each of the ten most frequently caught species using hook-and-line gear by area (Año Nuevo (AN), Point Lobos (PL), Piedras Blancas (BL), and Point Buchon (PB)) and site (Marine Protected Area (MPA) and reference (REF)), for all years combined.

Species	AN	AN MPA	AN REF	PL	PL MPA	PL REF
Black rockfish	1.32 (0.10)	1.12 (0.16)	1.49 (0.12)	0.18 (0.06)	0.11 (0.02)	0.26 (0.11)
Blue rockfish	0.56 (0.05)	0.60 (0.08)	0.52 (0.06)	1.91 (0.22)	2.98 (0.38)	0.81 (0.13)
China rockfish	0.07 (0.01)	0.04 (0.01)	0.10 (0.02)	0.07 (0.01)	0.10 (0.02)	0.03 (0.01)
Copper rockfish	0.01 (0.01)	0.03 (0.01)	<0.01 (<0.01)	0.23 (0.03)	0.41 (0.06)	0.05 (0.02)
Gopher rockfish	0.52 (0.04)	0.67 (0.07)	0.40 (0.04)	0.92 (0.06)	1.15 (0.08)	0.69 (0.07)
Kelp rockfish	0.01 (<0.01)	0.01 (0.01)	<0.01 (<0.01)	0.13 (0.02)	0.14 (0.02)	0.12 (0.07)
Lingcod	0.33 (0.04)	0.41 (0.07)	0.26 (0.05)	0.32 (0.06)	0.49 (0.10)	0.13 (0.04)
Olive rockfish	0.01 (<0.01)	0.01 (0.01)	<0.01 (<0.01)	1.01 (0.13)	1.67 (0.23)	0.32 (0.05)
Vermilion RF	0.12 (0.02)	0.13 (0.04)	0.11 (0.02)	0.26 (0.04)	0.43 (0.07)	0.08 (0.02)
Yellowtail RF	0.05 (0.01)	0.08 (0.03)	0.03 (0.01)	0.05 (0.01)	0.04 (0.01)	0.05 (0.01)

Species	BL	BL MPA	BL REF	PB	PB MPA	PB REF
Black rockfish	0.03 (0.01)	0.02 (0.01)	0.04 (0.02)	0.36 (0.04)	0.42 (0.06)	0.31 (0.05)
Blue rockfish	0.51 (0.10)	0.65 (0.16)	0.36 (0.10)	0.39 (0.05)	0.55 (0.08)	0.23 (0.03)
China rockfish	0.01 (<0.01)	0.02 (0.01)	<0.01 (<0.01)	0.02 (0.01)	0.04 (0.01)	0.01 (<0.01)
Copper rockfish	0.34 (0.05)	0.48 (0.08)	0.18 (0.06)	0.02 (0.01)	0.02 (0.01)	0.03 (0.01)
Gopher rockfish	0.91 (0.09)	0.89 (0.11)	0.93 (0.13)	1.13 (0.06)	1.29 (0.09)	0.98 (0.07)
Kelp rockfish	0.10 (0.03)	0.02 (0.01)	0.18 (0.06)	0.02 (<0.01)	0.03 (0.01)	0.01 (<0.01)
Lingcod	0.20 (0.03)	0.26 (0.06)	0.14 (0.03)	0.39 (0.04)	0.43 (0.06)	0.35 (0.06)
Olive rockfish	0.65 (0.13)	1.19 (0.20)	0.07 (0.03)	0.09 (0.01)	0.12 (0.02)	0.06 (0.02)
Vermilion RF	0.97 (0.13)	1.35 (0.21)	0.55 (0.12)	0.12 (0.02)	0.15 (0.03)	0.09 (0.02)
Yellowtail RF	0.08 (0.02)	0.10 (0.04)	0.05 (0.03)	0.07 (0.01)	0.08 (0.01)	0.06 (0.02)

Table 23. Average biomass in kilograms per trap hour (standard error) of the seven most frequently caught species using trap gear combined by area (Año Nuevo (AN), Point Lobos (PL), Piedras Blancas (BL), and Cambria (CA)) and site (Marine Protected Area (MPA) and reference (REF)). No values are listed for 2007 as the trap study was only conducted in 2008 and 2009.

		Kg per Trap Hour (SE)		
		All Years Combined	2008	2009
	AN	0.4 (<0.1)	0.4 (<0.1)	
	AN MPA	0.4 (<0.1)	0.4 (<0.1)	
	AN REF	0.4 (<0.1)	0.4 (<0.1)	
	PL	0.9 (<0.1)	1.1 (<0.1)	0.6 (<0.1)
	PL MPA	1.0 (<0.1)	1.3 (<0.1)	0.6 (<0.1)
	PL REF	0.7 (<0.1)	0.8 (<0.1)	0.7 (0.1)
	BL	0.5 (<0.1)	0.5 (<0.1)	0.5 (<0.1)
	BL MPA	0.5 (<0.1)	0.5 (<0.1)	0.5 (<0.1)
	BL REF	0.5 (<0.1)	0.5 (<0.1)	0.4 (<0.1)
	CA	0.7 (<0.1)	0.7 (<0.1)	0.6 (<0.1)
	CA MPA	0.8 (<0.1)	0.8 (<0.1)	0.7 (<0.1)
	CA REF	0.6 (<0.1)	0.7 (<0.1)	0.6 (<0.1)

Table 24. The average biomass in kilograms per angler hour (BPUE) and standard error (SE) for each of the seven most frequently caught species using trap gear by area (Año Nuevo (AN), Point Lobos (PL), Piedras Blancas (PB), and Cambria (CA)) and site (Marine Protected Area (MPA) and reference (REF)) for all years combined.

Species	AN	AN MPA	AN REF	PL	PL MPA	PL REF
Black-and-yellow rockfish	0.04 (0.01)	0.03 (0.02)	0.04 (0.01)	0.09 (0.01)	0.09 (0.02)	0.09 (0.02)
Cabazon	.017 (0.03)	0.11 (0.03)	0.25 (0.06)	0.21 (0.05)	0.19 (0.04)	0.25 (0.10)
Gopher rockfish	0.05 (0.01)	0.08 (0.02)	0.01 (0.01)	0.37 (0.05)	0.48 (0.08)	0.22 (0.06)
Grass rockfish	0.01 (0.01)	0.01 (0.01)	0.01 (0.01)	<0.01 (<0.01)	<0.01 (<0.01)	0.01 (<0.01)
Kelp greenling	0.05 (0.01)	0.06 (0.03)	0.40 (0.01)	0.11 (0.01)	0.09 (0.02)	0.12 (0.02)
Lingcod	0.04 (0.02)	0.06 (0.03)	0.02 (0.02)	0.11 (0.03)	0.15 (0.05)	0.05 (0.03)
Treefish	<0.01 (<0.01)	<0.01 (<0.01)	<0.01 (<0.01)	<0.01 (<0.01)	<0.01 (<0.01)	<0.01 (<0.01)

Species Code	BL	BL MPA	BL REF	CA	CA MPA	CA REF
Black-and-yellow rockfish	0.07 (0.01)	0.07 (0.01)	0.06 (0.01)	0.12 (0.01)	0.08 (0.01)	0.15 (0.02)
Cabazon	0.15 (0.02)	0.24 (0.04)	0.07 (0.02)	0.20 (0.03)	0.27 (0.05)	0.14 (0.03)
Gopher rockfish	0.19 (0.03)	0.10 (0.02)	0.27 (0.06)	0.28 (0.05)	0.26 (0.08)	0.30 (0.06)
Grass rockfish	<0.01 (<0.01)	<0.01 (<0.01)	<0.01 (<0.01)	0.01 (<0.01)	0.02 (0.01)	<0.01 (<0.01)
Kelp greenling	0.05 (0.01)	0.06 (0.01)	0.05 (0.01)	0.04 (0.01)	0.04 (0.01)	0.03 (0.01)
Lingcod	0.03 (0.01)	0.04 (0.02)	0.03 (0.01)	0.03 (0.01)	0.05 (0.02)	0.02 (0.01)
Treefish	<0.01 (0.01)	<0.01 (0.02)	<0.01 (0.01)	<0.01 (<0.01)	<0.01 (<0.01)	<0.01 (<0.01)

Table 25. Mean lengths of the ten most frequently caught species with hook-and-line gear, for each area and site, combining years. The mean length is presented with the standard error (SE), and below is the number of fish caught. If the mean length was greater in the MPA or REF site for an area, that length is shown in bold. If the bolded mean length is associated with an asterisk or ns, the data used in the Two-Factor ANOVA also conformed to all assumptions, and the p-values are valid). (ns: p-value>0.05, * : p-value ≤ 0.05, ** : p-value ≤ 0.001). A hyphen indicates that no fish were caught for that site, and/or the sample numbers are too low to generate a SE.

Species	Año Nuevo		Point Lobos	
	MPA Mean (SE) Number	REF Mean (SE) Number	MPA Mean (SE) Number	REF Mean (SE) Number
Black rockfish	33.4 (0.12) 575	31.3 (0.12) 1158	31.4 (0.38) 68	29.8 (0.22) 171
Blue rockfish	25.5 (0.19) 705	23.8 (0.16) 902	28.4 (0.09) 2942	26.8 (0.16) 928
China rockfish	28.2 ^{ns} (0.66) 28	29.6 ^{ns} (0.32) 79	29.7 ** (0.28) 79	27.0 (0.41) 24
Copper rockfish	33.2 * (1.70) 10	26.0 (-) 1	38.9 ** (0.52) 126	33.5 (1.54) 26
Gopher rockfish	28.0 (0.10) 504	28.4 (0.12) 367	26.8 (0.07) 1229	26.4 (0.10) 748
Kelp rockfish	34.0 (0) 2	37.0 (-) 1	30.8 ^{ns} (0.27) 115	30.3 ^{ns} (0.27) 109
Lingcod	57.3 (1.49) 72	60.5 (2.22) 43	62.1 ^{ns} (1.12) 79	57.4 ^{ns} (1.99) 25
Olive rockfish	30.8 (2.18) 12	34.0 (1.57) 8	35.6 (0.12) 966	34.4 (0.32) 219
Vermilion rockfish	34.0 (1.14) 48	37.5 (1.38) 42	40.9 (0.53) 122	37.7 (1.49) 26
Yellowtail rockfish	29.5 (0.89) 28	25.8 (0.75) 40	27.2 ^{ns} (0.64) 52	27.6 ^{ns} (0.70) 47

Table 25 cont. Mean lengths of the ten most frequently caught species with hook-and-line gear, for each area and site, combining years. The mean length is presented with the standard error (SE) in parentheses, and below is the number of fish caught. If the mean length was greater in the MPA or REF site for an area, that length is shown in bold. If the bolded mean length is associated with an asterisk or ns, the data used in the Two-Factor ANOVA also conformed to all assumptions, and the p-values are valid). (ns: p-value>0.05, * : p-value ≤ 0.05, ** : p-value ≤ 0.001). A hyphen indicates that no fish were caught for that site, and/or the sample numbers are too low to generate a SE.

Species	Piedras Blancas		Point Buchon	
	MPA	REF	MPA	REF
	Mean (SE) Number	Mean (SE) Number	Mean (SE) Number	Mean (SE) Number
Black rockfish	29.2 ^{ns} (1.09) 10	30.9 ^{ns} (0.54) 35	32.5 (0.19) 245	32.1 (0.22) 253
Blue rockfish	25.3 (0.24) 493	28.0 (0.31) 366	25.1 (0.21) 743	25.9 (0.26) 354
China rockfish	28.6 (0.46) 19	- (-) 0	28.7 ^{ns} (0.44) 31	29.0 ^{ns} (1.23) 7
Copper rockfish	40.9 ** (0.73) 72	34.3 (0.89) 55	30.5 ^{ns} (1.02) 18	32.0 ^{ns} (1.39) 19
Gopher rockfish	24.9 (0.09) 626	26.3 (0.09) 738	26.0 (0.07) 1442	26.6 (0.07) 1123
Kelp rockfish	33.3 ^{ns} (0.80) 8	31.5 ^{ns} (0.49) 32	31.2 ^{ns} (0.48) 22	32.3 ^{ns} (3.28) 3
Lingcod	58.9 ** (1.39) 49	50.5 (2.52) 37	56.1 * (1.05) 85	53.2 (1.16) 85
Olive rockfish	37.4 (0.25) 379	33.5 (0.61) 76	31.0 (0.48) 104	33.1 (0.40) 69
Vermilion rockfish	40.5 (0.36) 235	37.4 (0.55) 169	39.0 ** (0.70) 51	33.5 (0.90) 55
Yellowtail rockfish	29.0 (0.73) 49	26.9 (0.33) 64	27.3 (0.38) 102	28.2 (0.56) 72

Table 26. Mean lengths of the seven most frequently caught species with trap gear for each area and site, combining years. The mean length is presented with the standard error (SE), and number of fish caught below. Bolded mean lengths indicated a significant difference in mean lengths between sites, with the greater length being bolded. (If the bolded mean length is associated with an asterisk or ns, the data used in the Two-Factor ANOVA also conformed to all assumptions, and the p-values are valid). (ns: p-value>0.05, * : p-value ≤ 0.05, ** : p-value ≤ 0.001). A hyphen indicates that no fish were caught for that site, and/or the sample numbers are too low to generate a SE.

Species	Año Nuevo		Point Lobos	
	MPA	REF	MPA	REF
	Mean (SE) Number	Mean (SE) Number	Mean (SE) Number	Mean (SE) Number
Black-and-yellow rockfish	30.3* (0.32) 14	29.3 (0.27) 11	27.5 (0.24) 96	28.7** (0.25) 67
Cabezon	40.7 ^{ns} (1.49) 21	43.5 ^{ns} (0.91) 32	40.5 ^{ns} (0.46) 74	40.6 ^{ns} (0.62) 128
Gopher rockfish	30.1 (0.30) 41	29.6 (1.12) 5	27.7 (0.12) 429	27.4 (0.13) 252
Grass rockfish	39.0 ^{ns} (-) 1	35.3 ^{ns} (0.88) 3	36.0 ^{ns} (-) 1	33.8 ^{ns} (0.80) 5
Kelp greenling	37.2 ^{ns} (0.80) 16	35.9 ^{ns} (0.64) 14	37.2 ^{ns} (0.37) 59	36.7 ^{ns} (0.26) 73
Lingcod	63.7 ^{ns} (2.65) 6	72.0 ^{ns} (1.00) 2	61.8 ^{ns} (1.19) 19	62.9 ^{ns} (1.32) 8
Treefish	- (-) 0	- (-) 0	29.7 ^{ns} (1.45) 3	31.7 ^{ns} (1.20) 3

Table 26 cont. Mean lengths of the seven most frequently caught species with trap gear for each area and site, combining years. The mean length is presented with the standard error (SE) in parantheses, and number of fish caught below. Bolded mean lengths indicated a significant difference in mean lengths between sites, with the greater length being bolded. (If the bolded mean length is associated with an atserick or ns, the data used in the Two-Factor ANOVA also conformed to all assumptions, and the p-values are valid). (ns: p-value>0.05, * : p-value ≤ 0.05, ** : p-value ≤ 0.001). A hyphen indicates that no fish were caught for that site, and/or the sample numbers are too low to generate a SE.

Species	Cambria		Piedras Blancas	
	MPA	REF	MPA	REF
	Mean (SE) Number	Mean (SE) Number	Mean (SE) Number	Mean (SE) Number
Black-and-yellow rockfish	24.7 (0.13) 163	25.6 (0.12) 186	26.7 (0.29) 73	28.6** (0.29) 52
Cabezon	39.0 (0.31) 138	38.5 (0.45) 98	41.6 ^{ns} (0.45) 89	40.1 ^{ns} (0.66) 35
Gopher rockfish	26.2 (0.08) 534	25.8 (0.08) 520	28.3 (0.26) 92	28.4 (0.13) 219
Grass rockfish	37.0 ^{ns} (1.65) 9	36.2 ^{ns} (0.86) 5	- (-) 0	36.5 (0.50) 2
Kelp greenling	36.7 ^{ns} (0.29) 47	36.5 ^{ns} (0.62) 30	37.0 ^{ns} (0.33) 36	36.8 ^{ns} (0.39) 34
Lingcod	66.1* (0.95) 9	59.8 (2.80) 5	65.6 (1.27) 7	64.4 (3.12) 5
Treefish	29.5 ^{ns} (2.50) 2	30.7 ^{ns} (1.33) 3	- (-) 0	31.0 (-) 1

Table 27. Estimates of length and age at maturity for the ten most frequently caught species using hook-and-line gear. The values used for comparisons of age at maturity are highlighted in bold. References for each value have a superscript reference number. For each species, values are listed in order estimated through time (see references below for publication years.) All values have been standardized to total length in cm. *Note: asterisks indicate lengths that were converted to total lengths using equations found in the literature. Literature: 1) Wyllie Echeverria 1987, 2) Lea et al. 1999, 3) Rosenthal et al. 1982, 4) Miller et al. 1967, 5*) Reilly et al. (Males Only), 1994, 6) Romero 1988, 7) Phillips 1959, 8) Silberberg et al. 2001, 9) Love & Westphal 1981, and 10) Phillips 1964.

Hook & Line Top Ten Species			
Species	Female Length of First Maturity: TL (cm)	Female Length at 50% Maturity: TL (cm)	Age 50% Maturity: (yr)
Black rockfish	30.0 ⁽¹⁾ 44.2 ⁽²⁾	41.0 ⁽¹⁾ 40.2-44.3 ⁽³⁾	7 ⁽¹⁾ 9-12 ⁽³⁾
Blue rockfish	22.0 ⁽¹⁾ 19.6 ⁽²⁾	28.2 ⁽⁴⁾ 29.0 ⁽¹⁾	6 ⁽⁴⁾ 6 ⁽¹⁾
China rockfish	26.0 ⁽¹⁾ 26.2 ⁽²⁾	27.0 ⁽¹⁾	4 ⁽¹⁾
Copper rockfish	31.0 ⁽¹⁾ 29.5 ⁽²⁾	34.0 ⁽¹⁾	6 ⁽¹⁾
Gopher rockfish	17.0 ⁽¹⁾ 20.7 ⁽²⁾	17.0 ⁽¹⁾	4 ⁽¹⁾
Kelp rockfish	21.8 ⁽²⁾	26.0 ⁽⁵⁾ 21.2 ⁽⁶⁾	4-5 ⁽⁵⁾ 3.5 ⁽⁶⁾
Lingcod	58.4 ⁽⁷⁾ 45.1** ⁽⁸⁾	57.3** ⁽⁸⁾	3.8 ⁽⁸⁾
Olive rockfish	31.1 ⁽⁹⁾ 32.0 ⁽¹⁾ 28.5 ⁽²⁾	34.0 ⁽⁹⁾ 35.0 ⁽¹⁾	4 ⁽⁹⁾ 5 ⁽¹⁾
Vermilion rockfish	22.9 ⁽¹⁰⁾ 37.0 ⁽¹⁾ 36.5 ⁽²⁾	33.0 ⁽¹⁰⁾ 37.0 ⁽¹⁾	6 ⁽¹⁰⁾ 5 ⁽¹⁾
Yellowtail rockfish	27.0 ⁽¹⁾ 31.5 ⁽²⁾	36.0 ⁽¹⁾	7 ⁽¹⁾

Table 28. Estimates of length and age at maturity for the seven most frequently caught species using trap gear. The values used for comparison of length at maturity are highlighted in bold. References for each value have a superscript reference number. For each species, values are listed in order estimated through time (see references below for publication years.) All values have been standardized to total length in cm. *Note: asterisks indicate lengths that were converted to total lengths using equations found in the literature. Literature: 1) Wyllie Echeverria 1987, 2) Lea et al 1999, 3) O'Connell 1953, 4) Grebel 2003, 5) Love & Johnson 1998, 6) Rothrock 1973, 7) Phillips 1959, 8) Silberberg et al 2001, and 9) Colton & Larson 2007.

Species	Trapping Top Seven Species		
	Female Length of First Maturity: TL (cm)	Female Length at 50% Maturity: TL (cm)	Age 50% Maturity: (yrs)
Black-and-yellow rockfish	14.0 ⁽¹⁾ 24.3 ⁽²⁾	15.0 ⁽¹⁾	3 ⁽¹⁾
Cabezon	44.5 ⁽³⁾	33.7 ⁽⁴⁾	2.3 ⁽⁴⁾
Gopher rockfish	17.0 ⁽¹⁾ 20.7 ⁽²⁾	17.0 ⁽¹⁾	4 ⁽¹⁾
Grass rockfish	22 ⁽⁵⁾ 32.4 ⁽²⁾	24.0 ⁽⁵⁾	3.7 ⁽⁵⁾
Kelp greenling	31.6 ⁽⁶⁾	29.5 ⁽⁶⁾	3-4 ⁽⁶⁾
Lingcod	58.4 ⁽⁷⁾ 45.1** ⁽⁸⁾	57.3** ⁽⁸⁾	3.8 ⁽⁸⁾
Treefish	19.0 ⁽⁹⁾	19.0-19.9 ⁽⁹⁾	4 ⁽⁹⁾

Table 29. Median total lengths (cm), 75th percentile total lengths (cm), and maximum total lengths (cm) of the ten fish species most frequently caught with hook-and-line gear, from all areas, separated by MPA and REF sites, of 2009. (75th percentile lengths indicate that 75% of individuals of that population were smaller than that length). Total lengths (cm) of female 50% and 100% maturity are reported using the best and most current information available. (*) indicates that the length is between the species female 50% maturity total length and to 10% above, (**) indicates that that length is between 10-20% above, and (***) indicates that that length is 20% or more above. Bolded lengths indicate that the length is at or above female 100% maturity total length for that species. Please note references numbers indicating source information. (1: Wyllie Echeverria 1987, 2: Romero 1988, 3: Silberberg, et al 2001, FL converted to TL with Laidig et al 1997).

Common Name			Año Nuevo 2009		Point Lobos 2009	
	Female 50% Maturity: Length (cm)	Female 100% Maturity: Length (cm)	MPA Median 75th Maximum	REF Median 75th Maximum	MPA Median 75th Maximum	REF Median 75th Maximum
	Black rockfish	41.0 ¹	48.0 ¹	34.0 36.0 43.0*	33.0 35.0 42.0*	32.0 35.0 36.0
Blue rockfish	29.0 ¹	35.0 ¹	24.0 27.0 38.0	24.0 26.0 36.0	25.0 31.0* 38.0	24.0 26.0 33.0**
China rockfish	27.0 ¹	30.0 ¹	28.0* 30.0 31.0	30.0** 31.0 35.0	29.0* 30.0 33.0	27.0* 28.0* 29.0*
Copper rockfish	34.0 ¹	41.0 ¹	36.0* 38.0** 39.0**		39.0** 45.0 49.0	36.0* 44.0 52.0

Table 29 cont. Median total lengths (cm), 75th percentile total lengths (cm), and maximum total lengths (cm) of the ten fish species most frequently caught with hook-and-line gear, from all areas, separated by MPA and REF sites, of 2009. (75th percentile lengths indicate that 75% of individuals of that population were smaller than that length). Total lengths (cm) of female 50% and 100% maturity are reported using the best and most current information available. (*) indicates that the length is between the species female 50% maturity total length and to 10% above, (**) indicates that that length is between 10-20% above, and (***) indicates that that length is 20% or more above. Bolded lengths indicate that the length is at or above female 100% maturity total length. Please note references numbers indicating source information. (1: Wyllie Echeverria 1987, 2: Romero 1988, 3: Silberberg, et al 2001, FL converted to TL with Laidig et al 1997).

Gopher rockfish	17.0 ¹	21.0 ¹	28.0	29.0	27.0	26.0
			29.0	30.0	28.0	28.0
			33.0	33.0	32.0	32.0
Kelp rockfish	21.2 ²	28.7 ²	34.0		32.0	30.0
			34.0		32.0	33.0
			34.0		35.0	37.0
Lingcod	57.3 ³	76.5 ³	56.0	47.0	59.0*	50.0
			66.0**	62.0*	65.0**	64.0**
			78.0	78.0	70.0***	77.0***
Olive rockfish	35.0 ¹	39.0 ¹	41.0	33.0	37.0*	35.0*
			45.0	33.0	40.0	39.0
			45.0	33.0	43.0	43.0
Vermilion rockfish	37.0 ¹	46.0 ¹	30.0	32.0	40.0*	38.0*
			42.0**	44.0**	43.0**	42.0**
			49.0	47.0	49.0	46.0
Yellowtail rockfish	36.0 ¹	42.0 ¹	31.0	31.0	29.0	31.0
			34.0	31.0	31.0	32.0
			40.0**	34.0	33.0	36.0*

Table 29 cont. Median total lengths (cm), 75th percentile total lengths (cm), and maximum total lengths (cm) of the ten fish species most frequently caught with hook-and-line gear, from all areas, separated by MPA and REF sites, of 2009. (75th percentile lengths indicate that 75% of individuals of that population were smaller than that length). Total lengths (cm) of female 50% and 100% maturity are reported using the best and most current information available. (*) indicates that the length is between the species female 50% maturity total length and to 10% above, (**) indicates that that length is between 10-20% above, and (***) indicates that that length is 20% or more above. Bolded lengths indicate that the length is at or above female 100% maturity total length. Please note references numbers indicating source information. (1: Wyllie Echeverria 1987, 2: Romero 1988, 3: Silberberg, et al 2001, FL converted to TL with Laidig et al 1997).

Common Name	Female 50% Maturity: Length (cm)	Female 100% Maturity: Length (cm)	Piedras Blancas 2009		Point Buchon 2009	
			MPA	REF	MPA	REF
			Median 75th Maximum	Median 75th Maximum	Median 75th Maximum	Median 75th Maximum
Black rockfish	41.0 ¹	48.0 ¹	- 31.0 -	33.0 34.0 35.0	35.0 36.0 38.0	35.0 37.0 43.0
Blue rockfish	29.0 ¹	35.0 ¹	25.0 30.0* 38.0	30.0* 34.0** 38.0	28.0 29.0* 35.0	28.0 31.0* 35.0
China rockfish	27.0 ¹	30.0 ¹	30.0 30.0 30.0		30.0 30.0 34.0	
Copper rockfish	34.0 ¹	41.0 ¹	42.0 45.0 52.0	32.0 37.0* 50.0	39.0** 39.0** 46.0**	34.0* 37.0* 37.0*
Gopher rockfish	17.0 ¹	21.0 ¹	25.0 27.0 30.0	27.0 28.0 34.0	27.0 28.0 31.0	27.0 29.0 33.0

Table 29 cont. Median total lengths (cm), 75th percentile total lengths (cm), and maximum total lengths (cm) of the ten fish species most frequently caught with hook-and-line gear, from all areas, separated by MPA and REF sites, of 2009. (75th percentile lengths indicate that 75% of individuals of that population were smaller than that length). Total lengths (cm) of female 50% and 100% maturity are reported using the best and most current information available. (*) indicates that the length is between the species female 50% maturity total length and to 10% above, (**) indicates that that length is between 10-20% above, and (***) indicates that that length is 20% or more above. Bolded lengths indicate that the length is at or above female 100% maturity total length. Please note references numbers indicating source information. (1: Wyllie Echeverria 1987, 2: Romero 1988, 3: Silberberg, et al 2001, FL converted to TL with Laidig et al 1997).

Kelp rockfish	21.2 ²	28.7 ²	32.0 34.0 34.0	32.0 33.0 34.0	33.0 34.0 34.0	
Lingcod	57.3 ³	76.5 ³	55.0 58.0* 69.0***	40.0 55.0 64.0**	51.0 58.0* 74.0***	56.0 58.0* 61.0*
Olive rockfish	35.0 ¹	39.0 ¹	39.0 42.0 49.0	33.0 36.0* 40.0	30.0 35.0* 43.0	
Vermilion rockfish	37.0 ¹	46.0 ¹	41.0** 44.0** 48.0	36.0 39.0* 47.0	38.0* 40.0* 40.0*	26.0 32.0 42.0**
Yellowtail rockfish	36.0 ¹	42.0 ¹	31.0 32.0 35.0	28.0 29.0 32.0	31.0 32.0 34.0	31.0 33.0 37.0*

Table 30. Percent of catch at or above the length at 50% maturity (F50%) for females of the ten most frequently caught species with hook-and-line gear, for all areas and sites, years combined (N= number of fish caught in that area/site totaled for all years). Please note references numbers indicating source information: 1) Wyllie Echeverria 1987, 2) Romero 1988, and 3) Silberberg, et al 2001, (FL converted to TL with Laidig et al 1997).

Common Name	F50%: Length (cm) Age (yr)	Año Nuevo		Point Lobos		Piedras Blancas		Point Buchon	
		MPA	REF	MPA	REF	MPA	REF	MPA	REF
Black rockfish	41.0 ¹ 7	0.4%	0.5%	0.0%	0.0%	0.0%	0.0%	0.0%	0.4%
Blue rockfish	29.0 ¹ 6	26.7%	14.1%	55.3%	38.8%	27.8%	53.0%	27.2%	24.9%
China rockfish	27.0 ¹ 4	71.4%	87.3%	89.9%	58.3%	84.2%	NA (N=0)	83.9%	71.4%
Copper rockfish	34.0 ¹ 6	60.0%	0.0% (N=1)	84.1%	53.9%	88.9%	50.9%	16.7%	31.6%
Gopher rockfish	17.0 ¹ 4	100%	100%	100%	99.9%	99.8%	100%	99.9%	100%
Kelp rockfish	21.2 ² 3-4	100% (N=2)	100% (N=1)	100%	100%	100%	100%	100%	100%
Lingcod	57.3 ³ 3.8	59.7%	60.5%	64.6%	44.0%	51.0%	40.5%	38.8%	35.3%
Olive rockfish	35.0 ¹ 5	25.0%	37.5%	65.4%	53.9%	75.5%	42.1%	20.2%	26.1%
Vermilion rockfish	37.0 ¹ 5	35.4%	52.4%	82.8%	73.1%	83.0%	66.3%	78.4%	32.7%
Yellowtail rockfish	36.0 ¹ 7	13.6%	0.0%	5.8%	2.1%	10.2%	0.0%	0.0%	1.4%

Table 31. Median total lengths (cm), 75th percentile total lengths (cm), and maximum total lengths (cm) of the seven species most frequently caught trap gear, from all areas, separated by MPA and REF sites, from 2009. (75th percentile lengths indicate that 75% of individuals of that population were smaller than that length). Total lengths (cm) of female 50% and 100% maturity of each species are reported for reference. (*) indicates that the length is between the species female 50% maturity total length and to 10% above, (**) indicates that that length is between 10-20% above, and (***) indicates that that length is 20% or more above. Bolded lengths indicate that the length is at or above female 100% maturity total length. Please note references numbers indicating source information. (1: Wyllie Echeverria 1987, 2: Grebel 2003, 3: Love & Johnson 1998, 4: Rothrock, 1973, 5: Silberberg, et al 2001, FL converted to TL with Laidig et al 1997, 6: Colton & Larson 2007).

Common Name	Female 50% Maturity: Length (cm)	Female 100% Maturity: Length (cm)	Point Lobos 2009		Cambria 2009		Piedras Blancas 2009	
			MPA	REF	MPA	REF	MPA	REF
			Median 75 th Maximum	Median 75 th Maximum	Median 75 th Maximum	Median 75 th Maximum	Median 75 th Maximum	Median 75 th Maximum
Black-and-yellow Rockfish	15.0 ¹	19.0 ¹	28.0	28.0	26.0	26.0	27.0	29.0
			29.0	30.0	26.0	27.0	28.0	30.0
			34.0	33.0	29.0	30.0	32.0	31.0
Cabezon	33.7 ²	47.5 ²	40.0**	40.0**	40.0**	40.0**	40.0**	41.0***
			42.0***	44.0***	43.0***	45.0***	44.0***	44.0***
			49.0***	49.0***	51.0	52.0	50.0	47.0***
Gopher rockfish	17.0 ¹	21.0 ¹	27.0	27.0	27.0	26.0	28.0	28.0
			28.0	29.0	28.0	27.0	30.0	29.0
			33.0	32.0	30.0	30.0	32.0	32.0
Grass rockfish	24.0 ³	27.0 ³		34.0	36.0			
				34.0	40.0			
				34.0	40.0			
Kelp greenling	29.5 ⁴		38.0***	36.0***	37.0***	37.0***	38.0***	37.0***
			40.0***	38.0***	38.0***	37.0***	39.0***	38.0***
			43.0***	41.0***	42.0***	38.0***	41.0***	39.0***
Lingcod	57.3 ⁵	76.5 ⁵	61.0*	62.0*	63.0*	61.0*	70.0***	55.0
			68.0**	65.0**	66.0**	61.0*	72.0***	55.0
			70.0***	68.0**	66.0**	61.0*	72.0***	55.0
Treefish	20.9 ⁶	23.0 ⁶	31.0	34.0		32.0		
			32.0	34.0		32.0		
			32.0	34.0		32.0		

Table 32. Percent of catch at or above the length at 50% maturity (F50%) of females for the seven most frequently caught species with traps, for all areas and sites, years combined. (N=number of fish caught in that area/site totaled for all years). Please note references numbers indicating source information: 1) Wyllie Echeverria 1987, 2) Grebel 2003, 3) Love & Johnson 1998, 4) Rothrock, 1973, 5) Silberberg, et al 2001, (FL converted to TL with Laidig et al 1997), and 6) Colton & Larson 2007.

Common Name	F50%: Length (cm) Age (yrs)	Año Nuevo		Point Lobos		Cambria		Piedras Blancas	
		MPA	REF	MPA	REF	MPA	REF	MPA	REF
Black-and-yellow rockfish	15.0 ¹ 3	100%	100%	100%	100%	100%	100%	100%	100%
Cabezon	33.7 ² 2.3	85.7%	96.9%	97.3%	96.3%	96.4%	87.8%	98.9%	91.4%
Gopher rockfish	17.0 ¹ 4	100%	100%	100%	100%	100%	100%	100%	100%
Grass rockfish	24.0 ³ 3.7	100% N=1	100% N=2	100% N=1	100%	100%	100%	NA N=0	100% N=2
Kelp greenling	29.5 ⁴ 3-4	100%	100%	98.3%	100%	100%	96.7%	100%	97.1%
Lingcod	57.3 ⁵ 3.8	83.3%	100% N=2	79.0%	87.5%	100%	80.0%	100%	80.0%
Treefish	20.9 ⁶ 4	NA N=0	NA N=0	100% N=3	100% N=3	100% N=2	100% N=3	NA N=0	100% N=1

Table 33. Mean total lengths (cm) and skewness of the frequency distribution of the ten most frequently caught species with hook-and-line gear for each area and site, combining years. The mean length is presented with the standard error (SE), and number of fish caught. If the mean length was greater in the MPA or REF site for an area, that length is shown in bold. If the bolded mean length is associated with an asterisk or ns, the data used in the Two-Factor ANOVA also conformed to all assumptions, and the p-values are valid). (ns: p-value>0.05, * : p-value ≤ 0.05, ** : p-value ≤ 0.001). A hyphen indicates that no fish were caught for that site, and/or the sample numbers are too low to generate a SE. If the length frequency distributions of MPA or REF site for an area were found to be significantly different in two-sample K-S tests, the area with distributions which were skewed to right (i.e. more large fishes) are bolded, and level of significance indicated with asterisks. (*= p-value is less than or equal to p=0.05, **=p-value is less than or equal to 0.001). NS indicates that the distributions were not significantly different. NA indicates that there was not a large enough sample size to conduct tests.

Species	Año Nuevo			Point Lobos			Piedras Blancas			Point Buchon		
	MPA	REF	SKEW	MPA	REF	SKEW	MPA	REF	SKEW	MPA	REF	SKEW
	Mean (SE)	Mean (SE)		Mean (SE)	Mean (SE)		Mean (SE)	Mean (SE)		Mean (SE)	Mean (SE)	
	Number	Number		Number	Number		Number	Number		Number	Number	
Black rockfish	33.4 (0.12) 575	31.3 (0.12) 1158	MPA**	31.4 (0.38) 68	29.8 (0.22) 171	MPA*	29.2 ^{ns} (1.09) 10	30.9 ^{ns} (0.54) 35	NS	32.5 (0.19) 245	32.1 (0.22) 253	NS
Blue rockfish	25.5 (0.19) 705	23.8 (0.16) 902	MPA**	28.4 (0.09) 2942	26.8 (0.16) 928	MPA**	25.3 (0.24) 493	28.0 (0.31) 366	REF**	25.1 (0.21) 743	25.9 (0.26) 354	REF**
China rockfish	28.2 ^{ns} (0.66) 28	29.6 ^{ns} (0.32) 79	NS	29.7** (0.28) 79	27.0 (0.41) 24	MPA**	28.6 (0.46) 19	- (-) 0	NA	28.7 ^{ns} (0.44) 31	29.0 ^{ns} (1.23) 7	NS
Copper rockfish	33.2* (1.70) 10	26.0 (-) 1	NA	38.9** (0.52) 126	33.5 (1.54) 26	MPA*	40.9** (0.73) 72	34.3 (0.89) 55	MPA**	30.5 ^{ns} (1.02) 18	32.0 ^{ns} (1.39) 19	NS

Table 33 cont. Mean total lengths (cm) and skewness of the frequency distribution of the ten most frequently caught species with hook-and-line gear for each area and site, combining years. The mean length is presented with the standard error (SE), and number of fish caught. If the mean length was greater in the MPA or REF site for an area, that length is shown in bold. If the bolded mean length is associated with an asterisk or ns, the data used in the Two-Factor ANOVA also conformed to all assumptions, and the p-values are valid). (ns: p-value>0.05, * : p-value ≤ 0.05, ** : p-value ≤ 0.001). A hyphen indicates that no fish were caught for that site, and/or the sample numbers are too low to generate a SE. If the length frequency distributions of MPA or REF site for an area were found to be significantly different in two-sample K-S tests, the area with distributions which were skewed to right (i.e. more large fishes) are bolded, and level of significance indicated with asterisks. (*= p-value is less than or equal to p=0.05, **=p-value is less than or equal to 0.001). NS indicates that the distributions were not significantly different. NA indicates that there was not a large enough sample size to conduct tests.

Gopher rockfish	28.0 (0.10) 504	28.4 (0.12) 367	REF*	26.8 (0.07) 1229	26.4 (0.10) 748	MPA*	24.9 (0.09) 626	26.3 (0.09) 738	REF**	26.0 (0.07) 1442	26.6 (0.07) 1123	REF**
Kelp rockfish	34.0 (0) 2	37.0 (-) 1	NA	30.8 ^{ns} (0.27) 115	30.3 ^{ns} (0.27) 109	MPA*	33.3 ^{ns} (0.80) 8	31.5 ^{ns} (0.49) 32	NS	31.2 ^{ns} (0.48) 22	32.3 ^{ns} (3.28) 3	NS
Lingcod	57.3 (1.49) 72	60.5 (2.22) 43	NS	62.1 ^{ns} (1.12) 79	57.4 ^{ns} (1.99) 25	MPA*	58.9** (1.39) 49	50.5 (2.52) 37	NS	56.1* (1.05) 85	53.2 (1.16) 85	NS
Olive rockfish	30.8 (2.18) 12	34.0 (1.57) 8	NS	35.6 (0.12) 966	34.4 (0.32) 219	MPA*	37.4 (0.25) 379	33.5 (0.61) 76	MPA**	31.0 (0.48) 104	33.1 (0.40) 69	NS
Vermilion rockfish	34.0 (1.14) 48	37.5 (1.38) 42	NS	40.9 (0.53) 122	37.7 (1.49) 26	NS	40.5 (0.36) 235	37.4 (0.55) 169	MPA**	39.0** (0.70) 51	33.5 (0.90) 55	MPA**
Yellowtail rockfish	29.5 (0.89) 28	25.8 (0.75) 40	MPA**	27.2 ^{ns} (0.64) 52	27.6 ^{ns} (0.70) 47	NS	29.0 (0.73) 49	26.9 (0.33) 64	MPA*	27.3 (0.38) 102	28.2 (0.56) 72	NS

Table 34. Mean total lengths (cm) and skewness of the frequency distribution of the seven most frequently caught species with trap gear for each area and site, combining years. The mean length is presented with the standard error (SE), and number of fish caught below. Bolded mean lengths indicated a significant difference in mean lengths between sites, with the greater length being bolded. (If the bolded mean length is associated with an asterisk or ns, the data used in the Two-Factor ANOVA also conformed to all assumptions, and the p-values are valid). (ns: p-value>0.05, * : p-value ≤ 0.05, ** : p-value ≤ 0.001). A hyphen indicates that no fish were caught for that site, and/or the sample numbers are too low to generate a SE. If the length frequency distributions of MPA or REF site for an area were found to be significantly different in two-sample K-S tests, the area with distributions which were skewed to right (i.e. more large fishes) will be bolded, and level of significance indicated with asterisks. (*= p-value is less than or equal to p=0.05, **=p-value is less than or equal to 0.001). NS indicates that the distributions were not significantly different. NA indicates that there was not a large enough sample size to conduct tests.

Species	Año Nuevo			Point Lobos			Piedras Blancas			Cambria		
	MPA	REF	SKEW	MPA	REF	SKEW	MPA	REF	SKEW	MPA	REF	SKEW
	Mean (SE)	Mean (SE)		Mean (SE)	Mean (SE)		Mean (SE)	Mean (SE)		Mean (SE)	Mean (SE)	
Black-and-yellow rockfish	30.3* (0.32) 14	29.3 (0.27) 11	NS	27.5 (0.24) 96	28.7** (0.25) 67	REF**	26.7 (0.29) 73	28.6** (0.29) 52	REF**	24.7 (0.13) 163	25.6 (0.12) 186	
Cabezon	40.7 ^{ns} (1.49) 21	43.5 ^{ns} (0.91) 32	NS	40.5 ^{ns} (0.46) 74	40.6 ^{ns} (0.62) 128	NS	41.6 ^{ns} (0.45) 89	40.1 ^{ns} (0.66) 35	NS	39.0 (0.31) 138	38.5 (0.45) 98	NS
Gopher rockfish	30.1 (0.30) 41	29.6 (1.12) 5	NS	27.7 (0.12) 429	27.4 (0.13) 252	NS	28.3 (0.26) 92	28.4 (0.13) 219	MPA**	26.2 (0.08) 534	25.8 (0.08) 520	NS

Table 34 cont. Mean total lengths (cm) and skewness of the frequency distribution of the seven most frequently caught species with trap gear for each area and site, combining years. The mean length is presented with the standard error (SE), and number of fish caught below. Bolded mean lengths indicated a significant difference in mean lengths between sites, with the greater length being bolded. (If the bolded mean length is associated with an asterisk or ns, the data used in the Two-Factor ANOVA also conformed to all assumptions, and the p-values are valid). (ns: p-value>0.05, * : p-value ≤ 0.05, ** : p-value ≤ 0.001). A hyphen indicates that no fish were caught for that site, and/or the sample numbers are too low to generate a SE. If the length frequency distributions of MPA or REF site for an area were found to be significantly different in two-sample K-S tests, the area with distributions which were skewed to right (i.e. more large fishes) will be bolded, and level of significance indicated with asterisks. (*= p-value is less than or equal to p=0.05, **=p-value is less than or equal to 0.001). NS indicates that the distributions were not significantly different. NA indicates that there was not a large enough sample size to conduct tests.

Grass rockfish	39.0 ^{ns} (-) 1	35.3 ^{ns} (0.88) 3	NA	36.0 ^{ns} (-) 1	33.8 ^{ns} (0.80) 5	NA	- (-) 0	36.5 (0.50) 2	NS	37.0 ^{ns} (1.65) 9	36.2 ^{ns} (0.86) 5	NA
Kelp greenling	37.2 ^{ns} (0.80) 16	35.9 ^{ns} (0.64) 14	NS	37.2 ^{ns} (0.37) 59	36.7 ^{ns} (0.26) 73	NS	37.0 ^{ns} (0.33) 36	36.8 ^{ns} (0.39) 34	NS	36.7 ^{ns} (0.29) 47	36.5 ^{ns} (0.62) 30	NS
Lingcod	63.7 ^{ns} (2.65) 6	72.0 ^{ns} (1.00) 2	NS	61.8 ^{ns} (1.19) 19	62.9 ^{ns} (1.32) 8	NS	65.6 (1.27) 7	64.4 (3.12) 5	NS	66.1* (0.95) 9	59.8 (2.80) 5	NS
Treefish	- (-) 0	- (-) 0	NA	29.7 ^{ns} (1.45) 3	31.7 ^{ns} (1.20) 3	NS	- (-) 0	31.0 (-) 1	NS	29.5 ^{ns} (2.50) 2	30.7 ^{ns} (1.33) 3	NA

Table 35. Number of tag returns grouped by area of release and method of report to CCFRP. Note that though fishers may have caught fish that had been released in the MPA sites, the groupings do not imply that they were fishing in the MPAs .

Area	CCFRP Caught	Fisher Caught	Diver Observed	Only Tag Found	Total Recaptured
AN					
MPA	2	2	0	1	5
REF	4	17	0	1	22
PL					
MPA	17	1	1	19	38
REF	1	17	0	9	27
CA					
MPA	7	0	0	0	7
REF	7	17	0	0	24
BL					
MPA	0	1	0	0	1
REF	2	2	0	0	4
PB					
MPA	2	4	0	0	6
REF	3	16	0	0	19
Total	45	77	1	30	153

Table 36. All fish recaptures reported, including number of each species recaptured, and both range and mean number of days at liberty and distance traveled as of April 2010, by parties reporting. Values of days at liberty and distance moved recorded in the some of the literature are also shown for reference. References: 1) Lea et al 1999, 2) Matthews 1986, 3) Miller & Geibel 1973, 4) Hartmann 1987, 5) Allen et al 2006, pg 524-553, 6) DeMott 1983, 7) Starr et al. 2004, 8) Karpov et al 2000, and 9) Jan Freiwald 2010.

Species	CCFRP Recaptures			Fishermen/Diver Reports			Literature Values	
	Number Returned	Time at Liberty: Range, Mean (days)	Movement: Range, Mean (km)	Number Returned	Time at Liberty: Range, Mean (days)	Movement: Range, Mean (km)	Time at Liberty: Range, (days)	Movement: Range, Mean (km)
Black-and-yellow rockfish	0			3	213-364 292.3	0.22-21.17 9.81	4-1263 ¹ 13-56 ²	<0.19 ¹ 0.8-1.6 ² 0.05-1.5 ⁵
Black rockfish	3	39-316 135.3	0.07-0.13 0.1	12	5-587 183.2	0.02-885.66 133.12	18-552 ¹ ?-1,357 ⁶	<0.19 ¹ >5 ⁶
Blue rockfish	4	1-331 247.5	0.08-0.63 0.22	6	23-623 171.5	0.18-58.21 11.58	11-502 ¹ 1-1,130 ³ 20-767 ⁴	<0.19 ¹ <1.61-24.14 ³ <1.0-43 ⁴
Brown rockfish	1	381	0.06	2	8-342 175.0	0.13-0.50 0.32	149 ¹ 77?-108 ⁴	<0.19 ¹ 1-2.4 ⁴ 8 ⁵
Cabezon	3	2-356 225.0	0.01-0.04 0.03	1	173	0.12	18-54 ¹	<0.19 ¹ 0-25 ⁸
Canary rockfish	1	305	0.10	2	67-468 267.5	0.16-0.24 0.20	1114-1439 ¹ 335?-615 ⁶	6.48-703.76 ¹ 0?-236 ¹
China rockfish	0			1	6	1.14	217 ¹	<0.19 ¹ 0-38 ⁸
Copper rockfish	7	0-734 278.1	0.01-0.83 0.19	2	27-293 160.0	0.27-12.67 6.47	22-3944 ¹ 136?-1,317 ⁴	<0.19 -2.04 ¹ 0-2.6 ¹ 6.4 ⁵
Gopher rockfish	20	2-409 192.1	>0.01-0.21 0.04	41	78-729 377.02	0.02-58.26 3.92	22-3944 ¹ 28-372 ²	<0.19 -2.04 ¹ 0.8-1.6 ² 0-38 ⁸
Kelp greenling	2	317	0.02-0.03 0.03	0				0.005-0.02 ⁹

Table 36 cont. All fish recaptures reported, including number of each species recaptured, and both range and mean number of days at liberty and distance traveled as of April 5, 2010, by parties reporting. Values of days at liberty and distance moved recorded in the some of the literature are also shown for reference. References: 1) Lea et al 1999, 2) Matthews 1986, 3) Miller & Geibel 1973, 4) Hartmann 1987, 5) Allen et al 2006, pg 524-553, 6) DeMott 1983, 7) Starr et al 2004, 8) Karpov et al 2000, and 9) Jan Freiwald 2010.

Lingcod	0			4	71-278 181.75	0.10-2.21 0.95	3-950 ¹ ?-311 ⁶	<0.19 -124.08 ¹ 1.6-4.8 ³ <10-50 ⁷
Olive rockfish	2	281-357 319.0	0.07-0.08 0.07	0			9-1413 ¹ 8-484 ⁴	<0.19 -1.85 ¹ 0.7-33 ⁴
Yellowtail rockfish	2	20-700 360.0	0.04-0.17 0.10	0			66-1786 ¹	<0.19 -181.50 ¹ 3.7-22.5 ⁵

Table 37. General movements categories of fishes recaptured during this project, in reference to study site and grid cell spaces defined by CCFRP protocols (Appendix 1), and species which fall into selected categories. Numbers of fish representing each category are displayed in parentheses.

Net Movements		
Inside: Site & Grid Cell (75)	Outside: Grid Cell Only- (26)	Outside: Site- (18)
Black-and-yellow rockfish (1)	Black rockfish (2)	Black-and-yellow rockfish (2)
Black rockfish (8)	Blue rockfish (6)	Black rockfish (5)
Blue rockfish (3)	Brown rockfish (1)	Blue rockfish (1)
Brown rockfish (2)	China rockfish (1)	Copper rockfish (1)
Cabazon (4)	Copper rockfish (1)	Gopher rockfish (9)
Canary rockfish (3)	Gopher rockfish (13)	
Copper rockfish (7)	Lingcod (2)	
Gopher rockfish (39)		
Kelp greenling (2)		
Lingcod (2)		
Olive rockfish (2)		
Yellowtail rockfish (2)		



Figure 1. Map of the Central Coast and North Central Coast State Marine Conservation Areas (SMCAs) and State Marine Reserves (SMRs) surveyed by the hook-and-line protocols developed by the California Collaborative Fisheries Research Program. *Note: Only the areas in red are considered in this report.

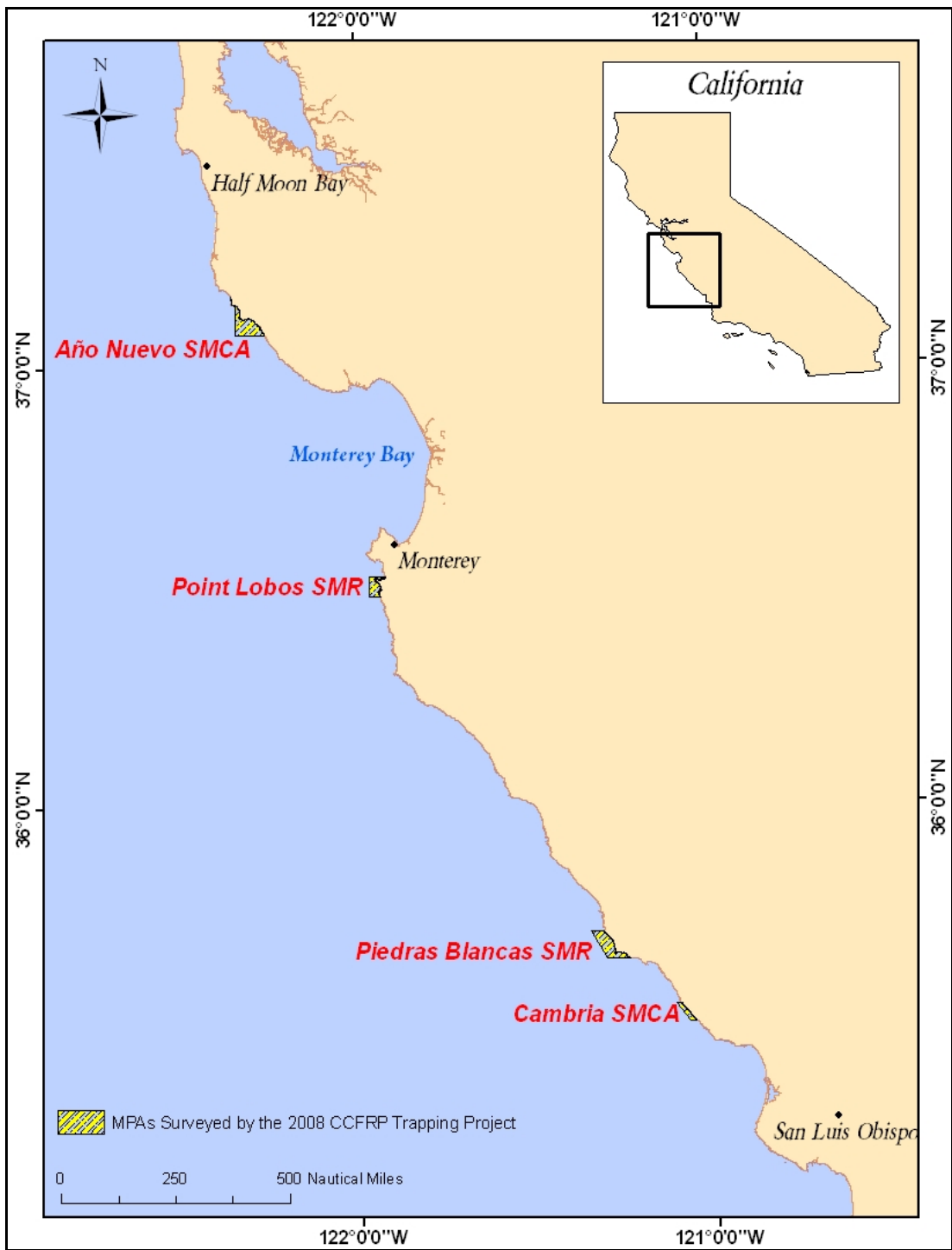
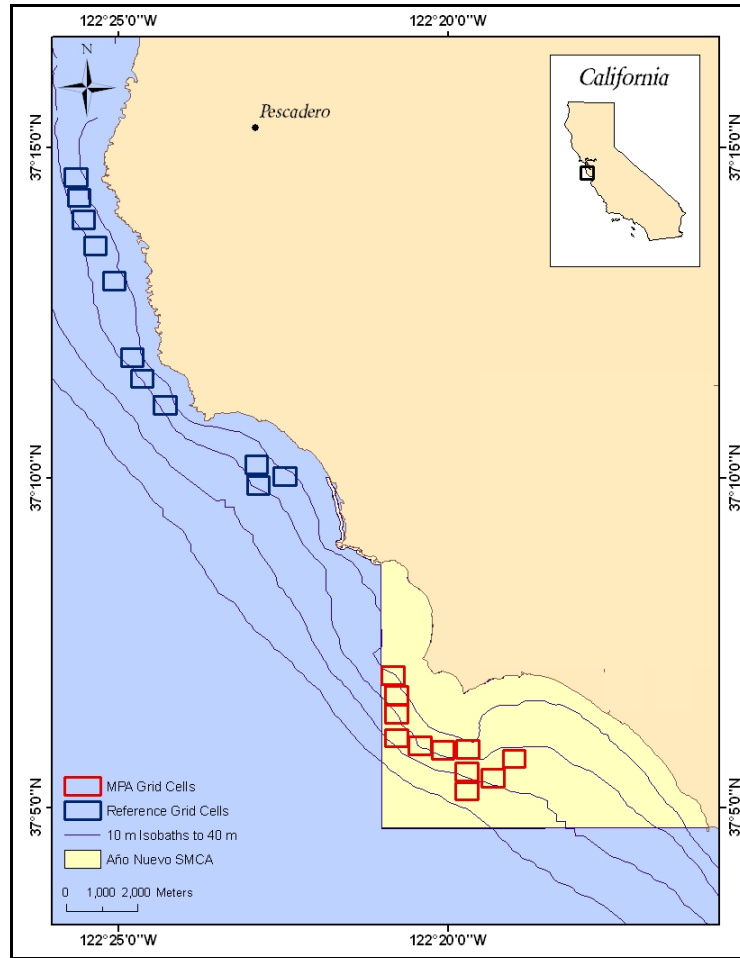

Figure 2. The State Marine Conservation Areas (SMCAs) and State Marine Reserves (SMRs) that were surveyed by the 2008 and 2009 California Collaborative Fisheries Research Program (CCFRP) trapping project.

A)



B)

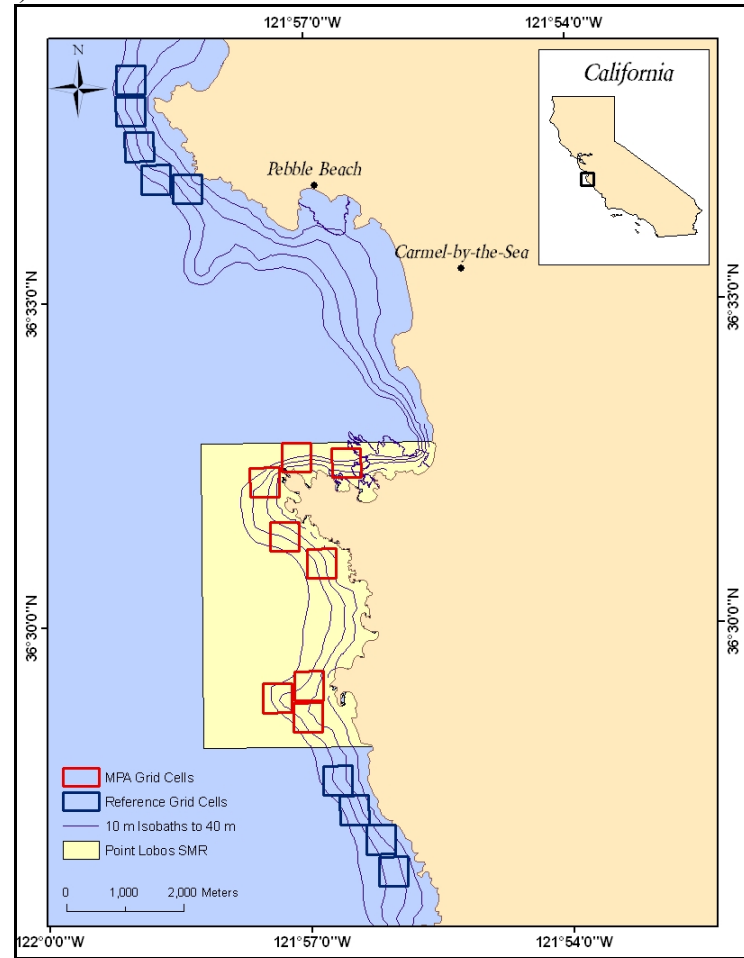

Figure 3. The 500 m x 500 m hook-and-line survey grid cells, which delineate the sampling locations within the marine protected areas and corresponding reference sites, for A) the Año Nuevo MPA, B) the Point Lobos MPA.

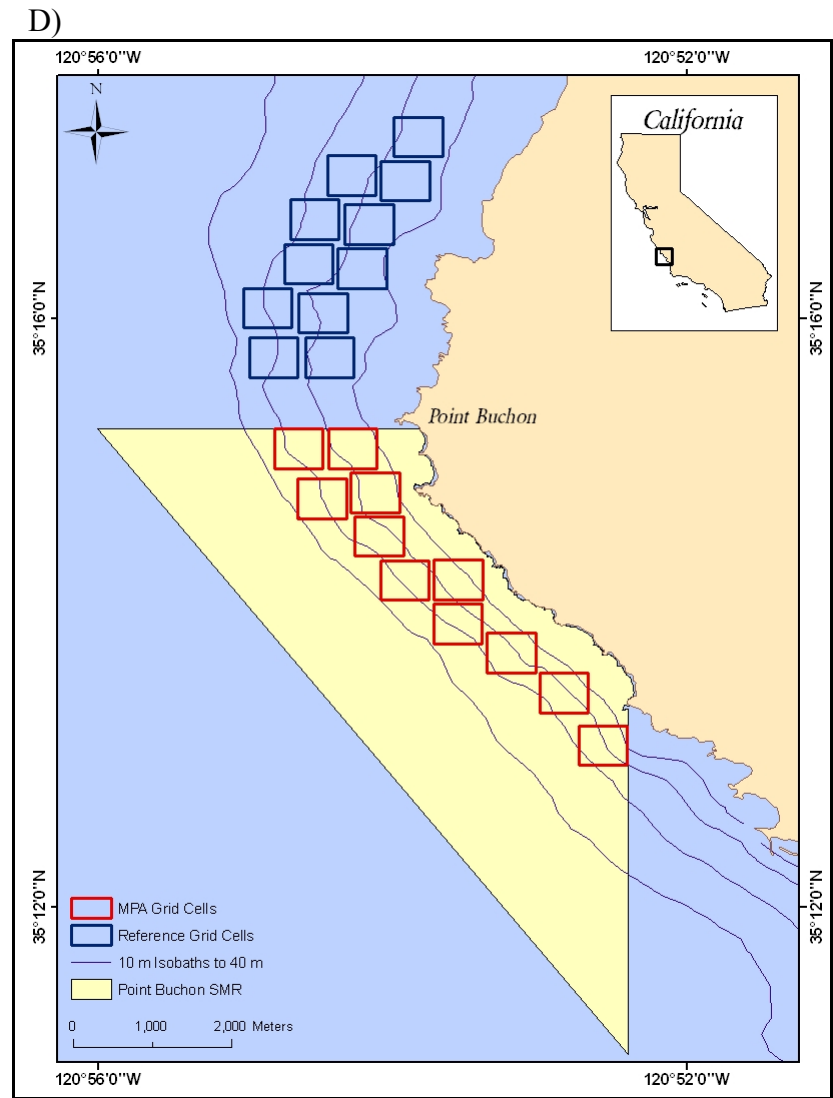
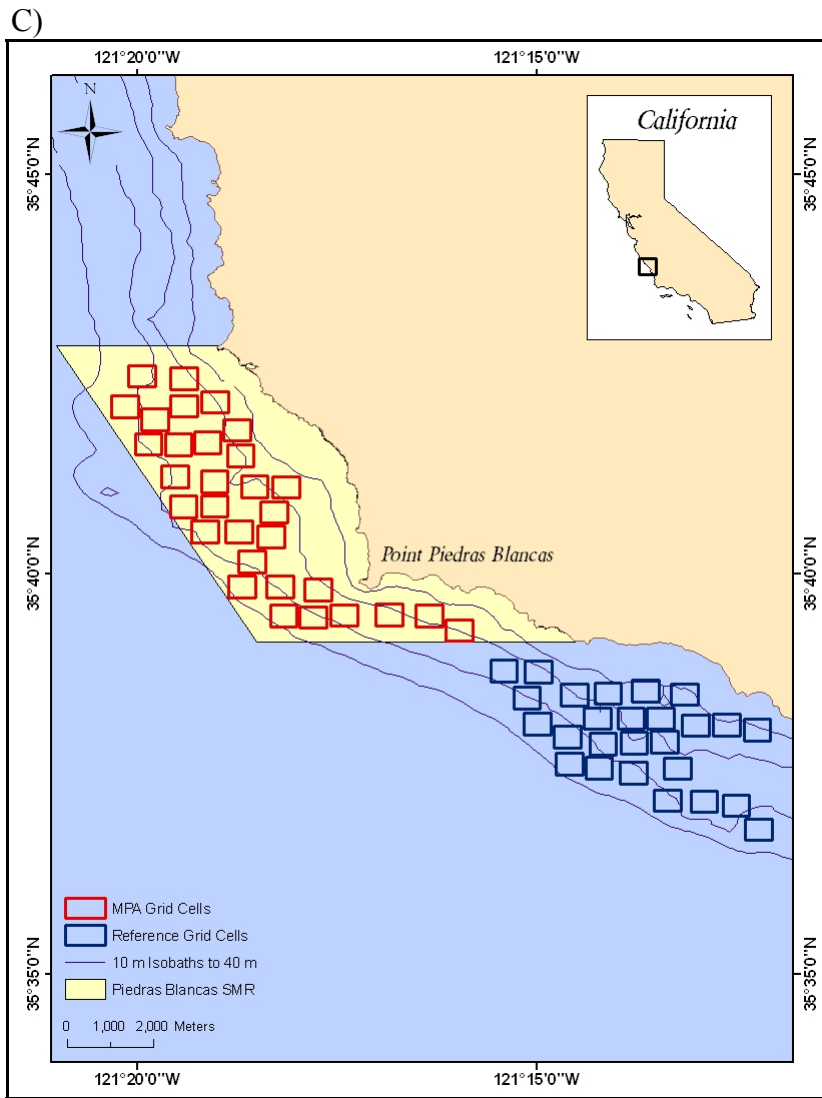

Figure 3 cont. The 500 m x 500 m hook-and-line survey grid cells, which delineate the sampling locations within the marine protected areas and corresponding reference sites for, C) the Piedras Blancas MPA, and D) the Point Buchon MPA.

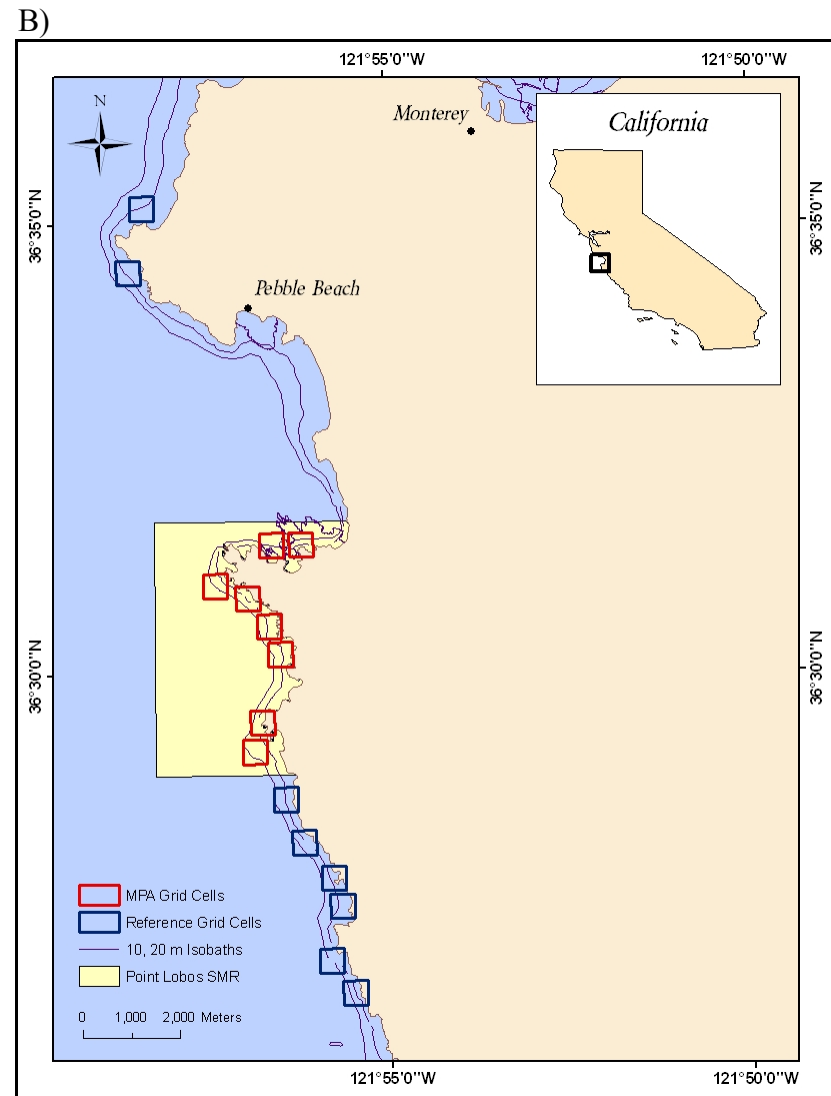
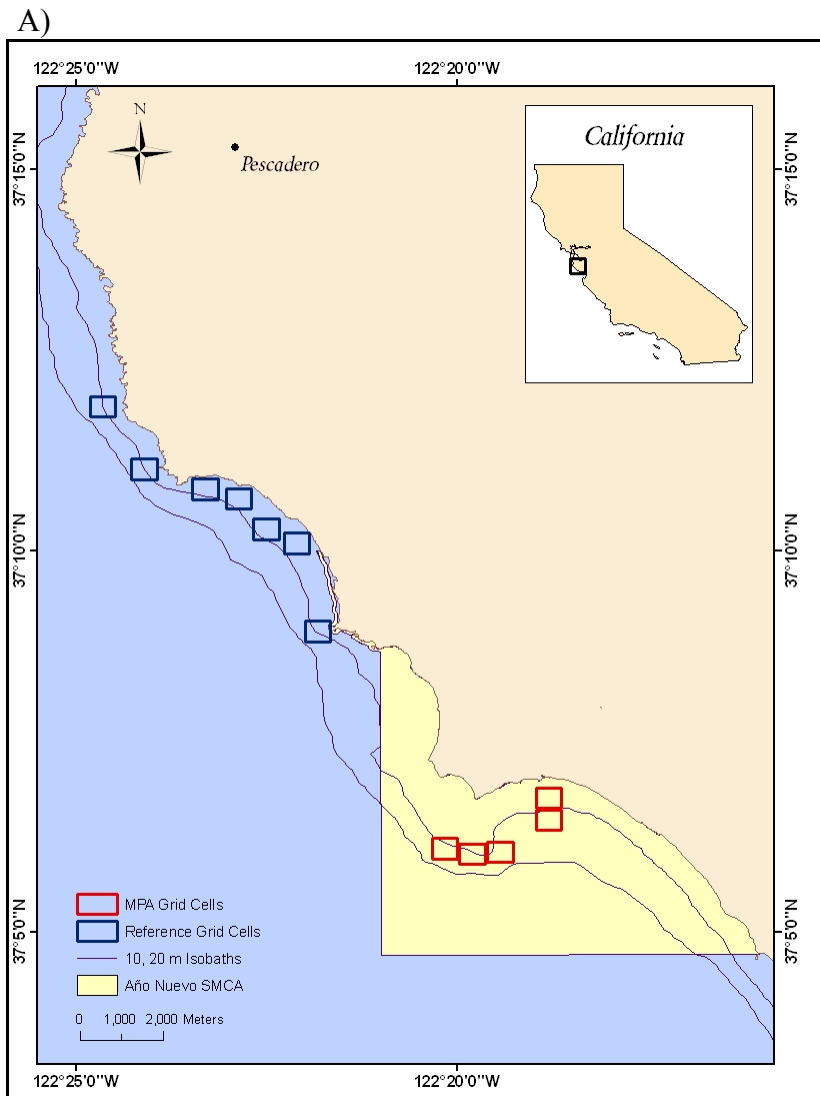

Figure 4. The 500 m x 500 m trapping survey grid cells, which delineate the marine protected areas and corresponding reference sites, for A) the Añõ Nuevo MPA and B) the Point Lobos MPA.

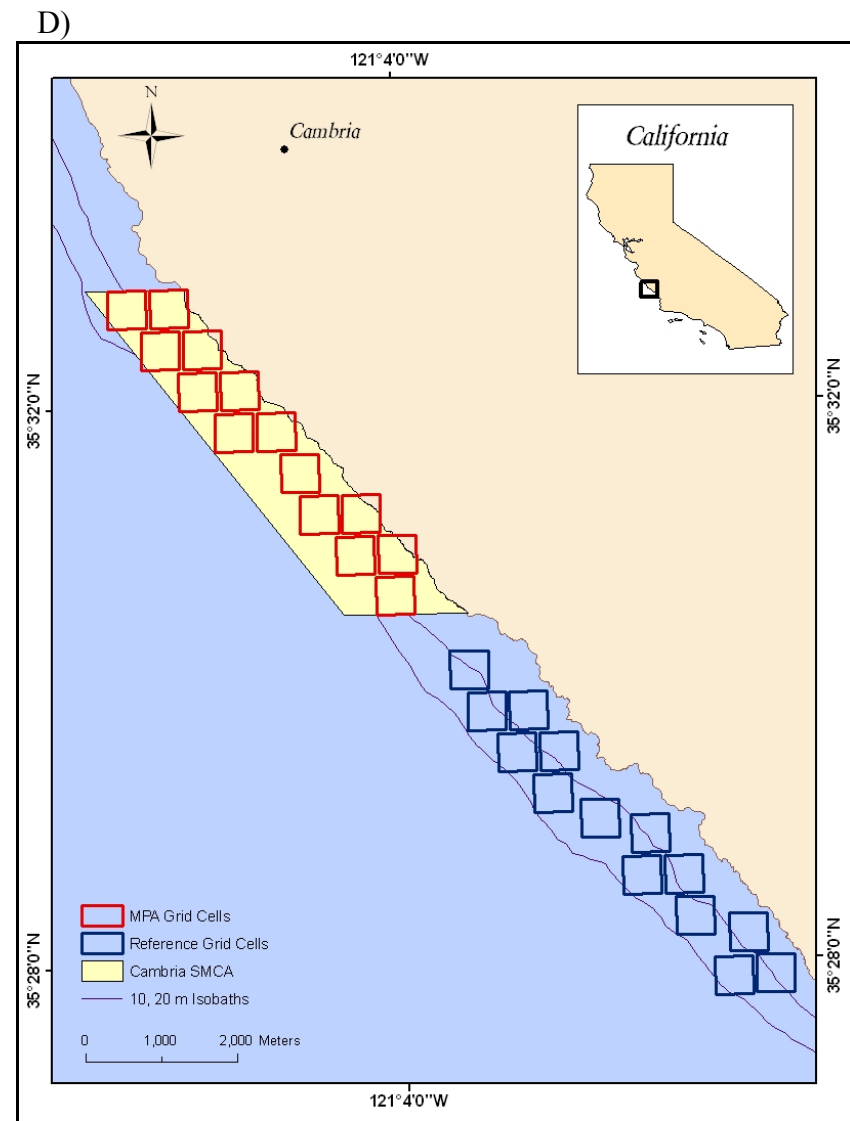
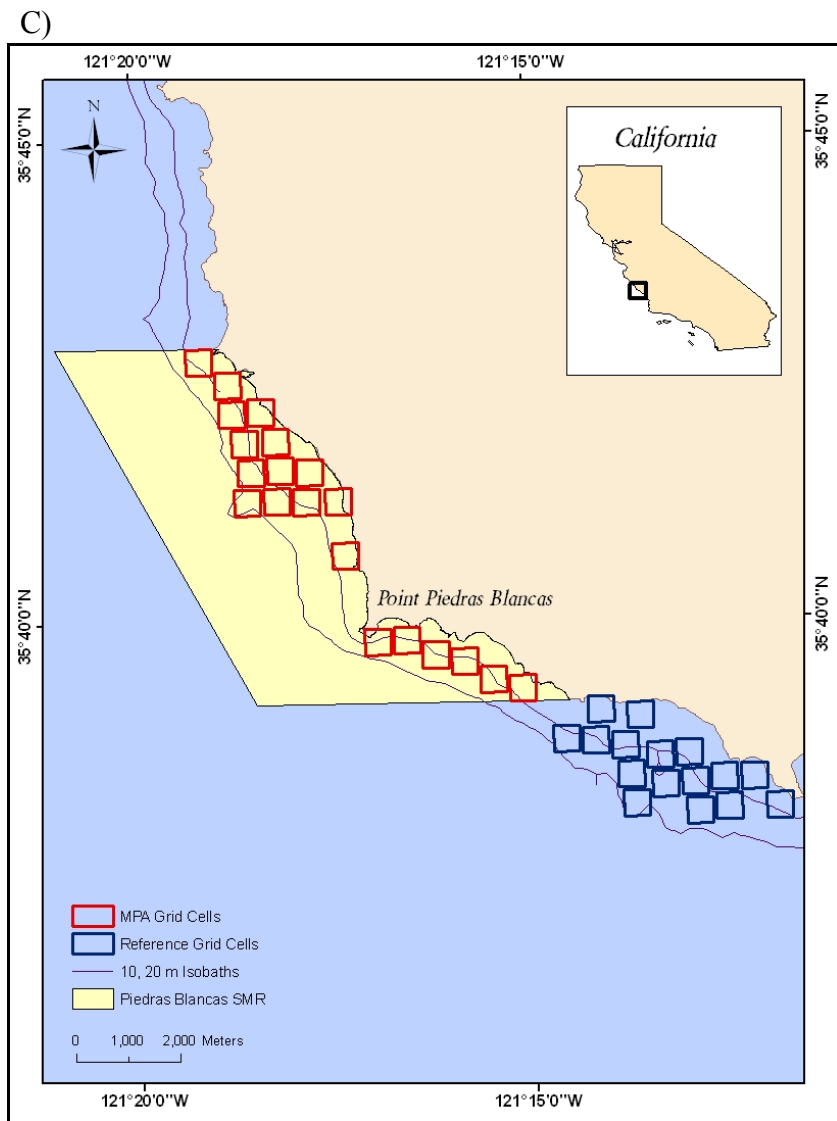
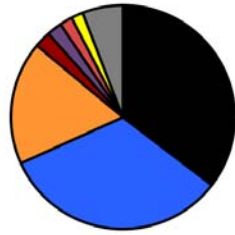

Figure 4 cont. The 500 m x 500 m trapping survey grid cells, which delineate the marine protected areas and corresponding reference sites, for C) the Piedras Blancas MPA and D) the Cambria MPA.

Año Nuevo MPA & REF (2007-2009)



n = 4,900

Piedras Blancas MPA & REF (2008-2009)

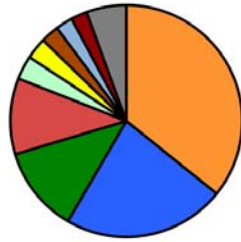

n = 3,826

Point Lobos MPA & REF (2007-2009)

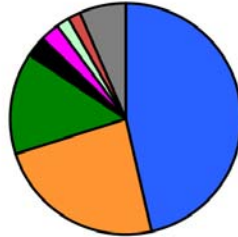

n = 8,356

Point Buchon MPA & REF (2007-2009)

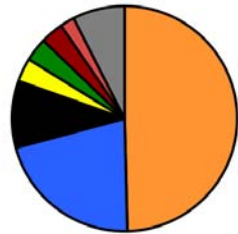

n = 5,193

- Black Rockfish
- Blue Rockfish
- Brown Rockfish
- Canary Rockfish
- China Rockfish
- Copper Rockfish
- Gopher Rockfish
- Lingcod
- Olive Rockfish
- Vermilion Rockfish
- Yellowtail Rockfish
- Other

Figure 5. Species composition by area. Pie charts show species composition for Marine Protected Areas and reference sites combined, and reveal geographic differences in species composition. The species shown represent 1.5% or more of the total catch. Species comprising less than 1.5% are grouped as "Other."

A)

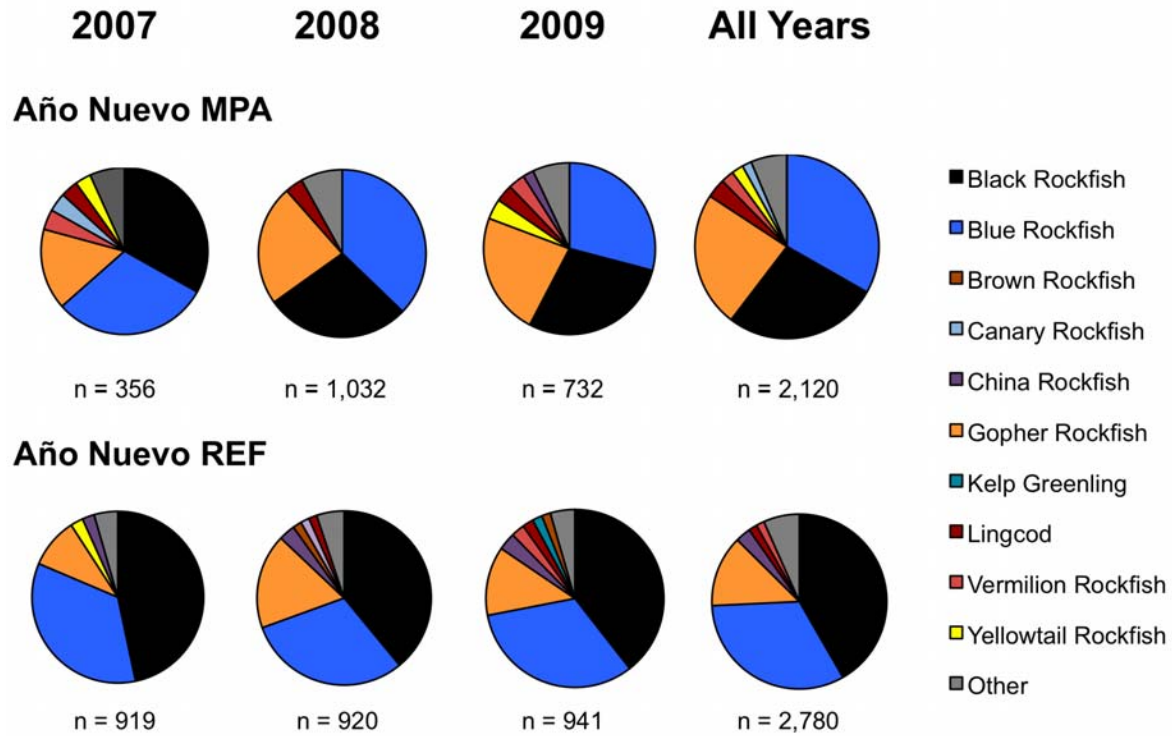

B)

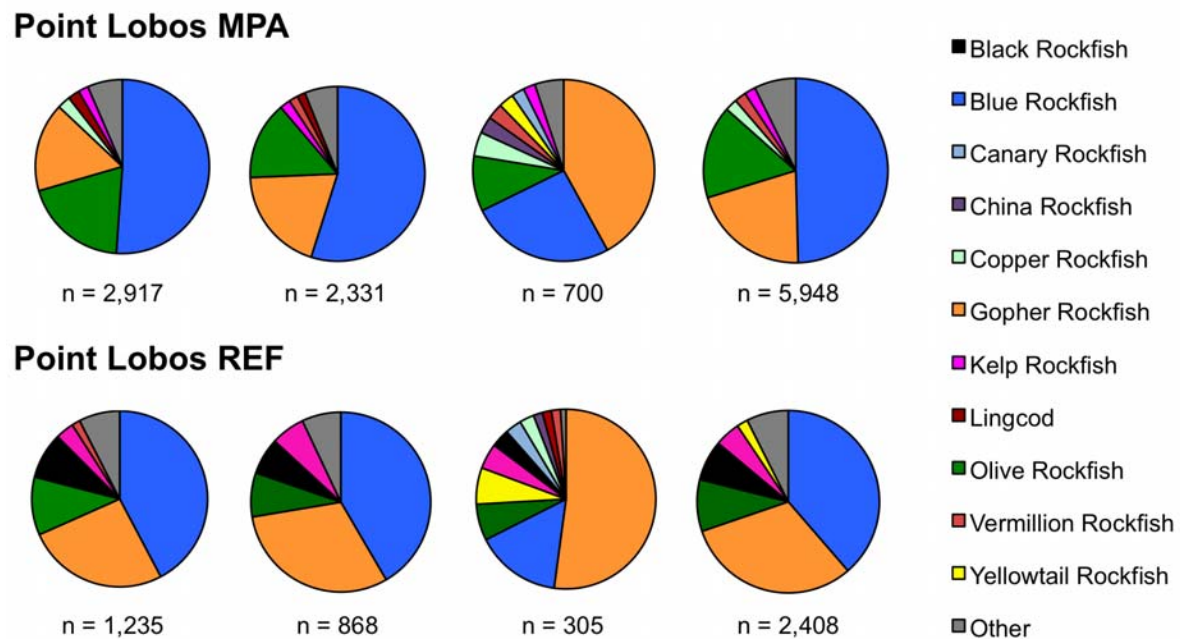
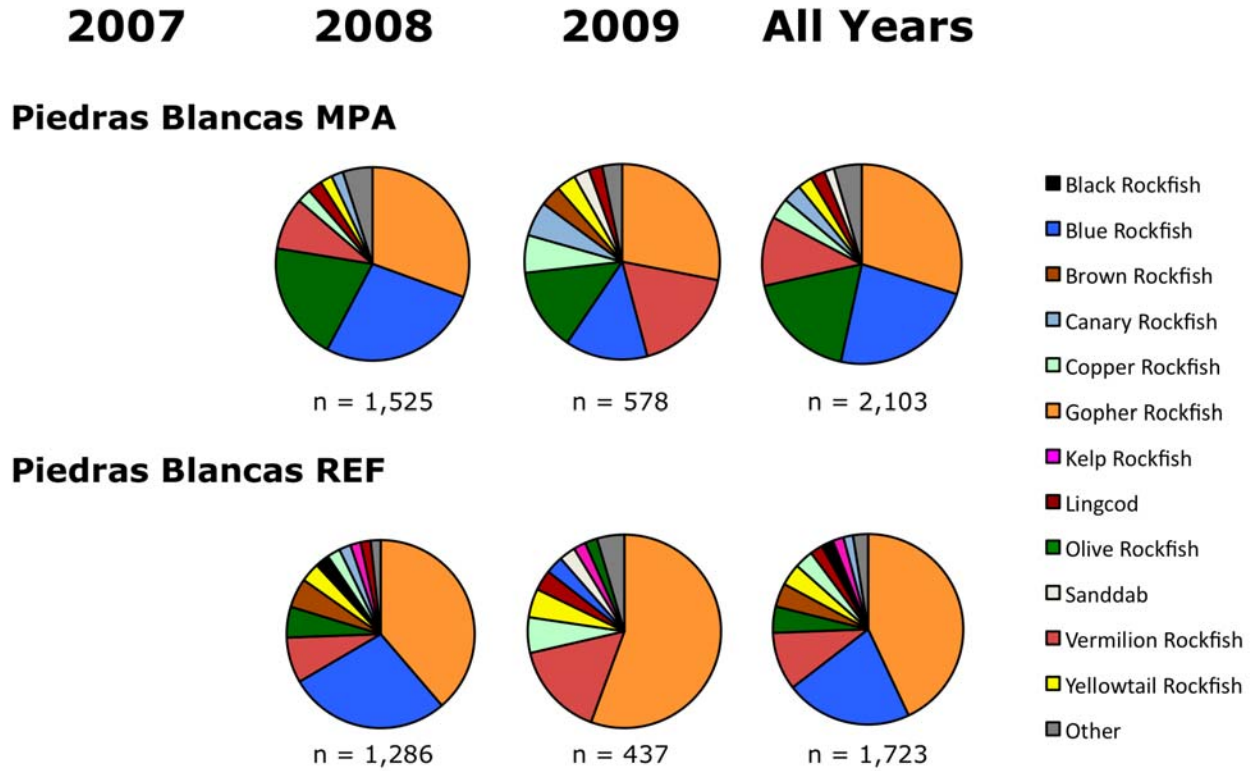

Figure 6. Species composition of hook-and-line surveys. Pie charts show comparisons between the Marine Protected Area (MPA) and reference site (REF) at A) Año Nuevo, and B) Point Lobos. All pie charts show species comprising 1.5% or greater of the total catch. Species comprising less than 1.5% of the total are grouped as “Other”.

C)



D)

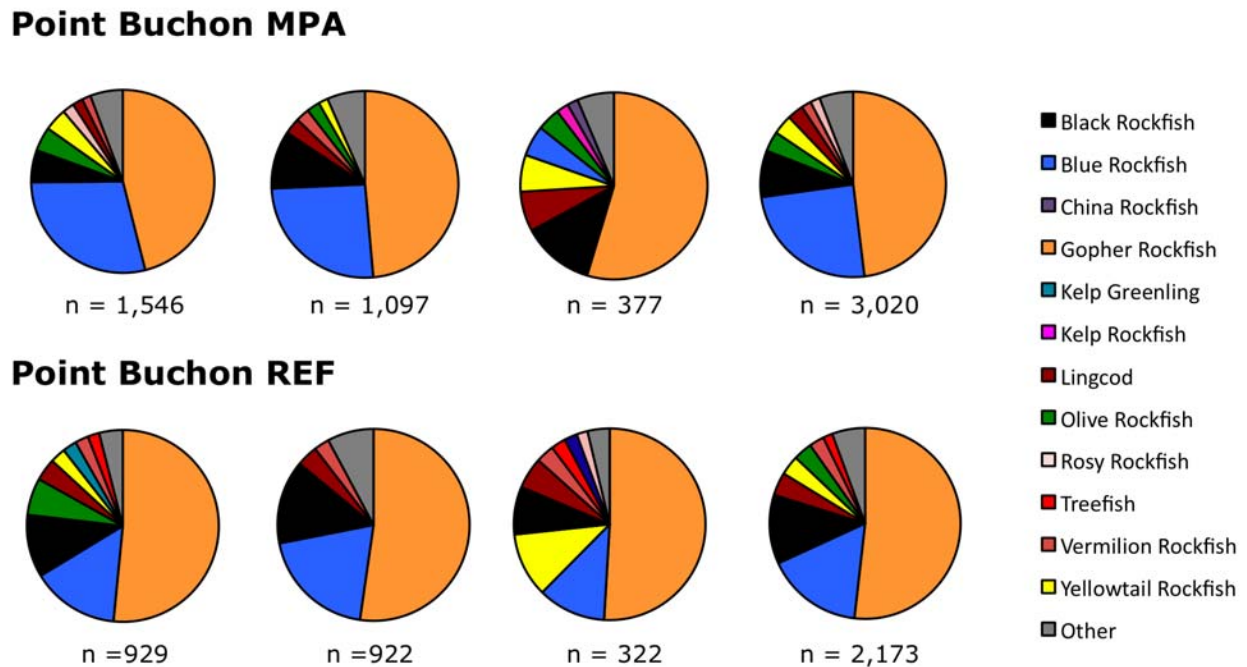

Figure 6 cont. Species composition of hook-and-line surveys. Pie charts show comparisons between the Marine Protected Area (MPA) and reference site (REF) at C) Piedras Blancas, and D) Point Buchon. All pie charts show species comprising 1.5% or greater of the total catch. Species comprising less than 1.5% of the total are grouped as “Other”.

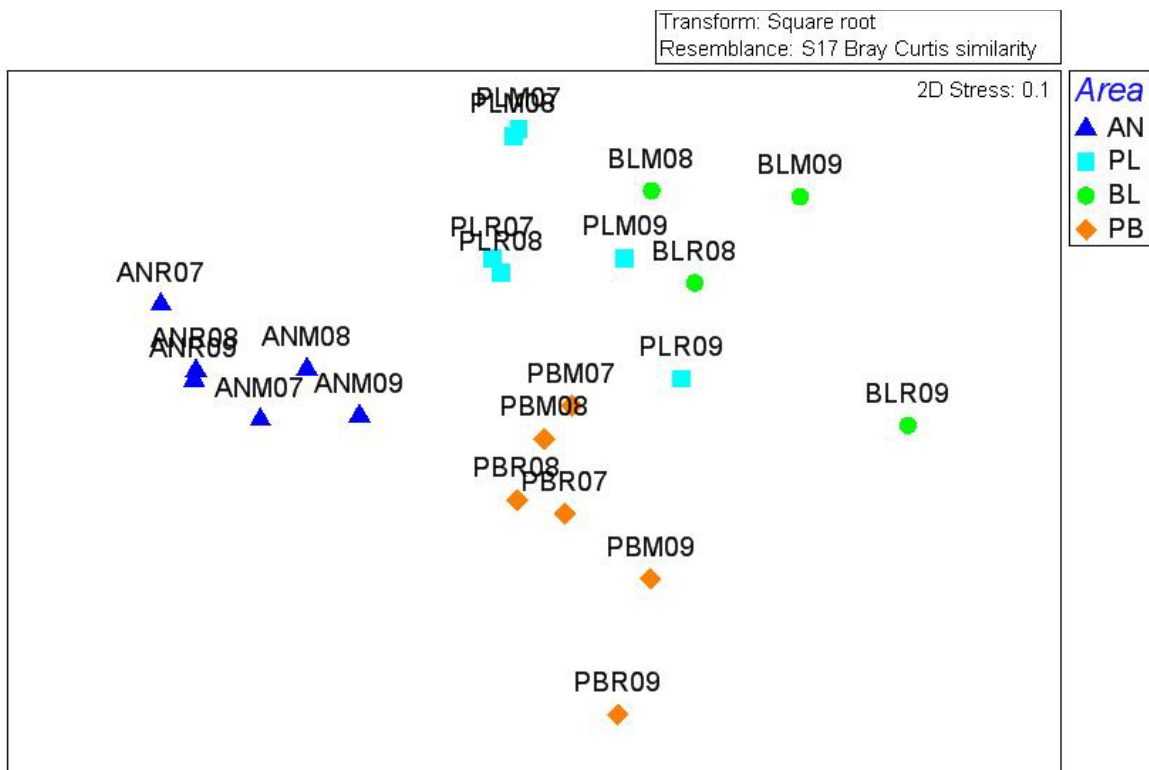

Figure 7. Bray-Curtis Multi-Dimensional Scaling plot for comparisons in species catch composition among areas, sites, and years for data collected in hook-and-line surveys. (AN = Año Nuevo, PL = Point Lobos, BL = Piedras Blancas, PB = Point Buchon, M = MPA, R = REF, 07 = 2007, 08 = 2008, 09 = 2009).

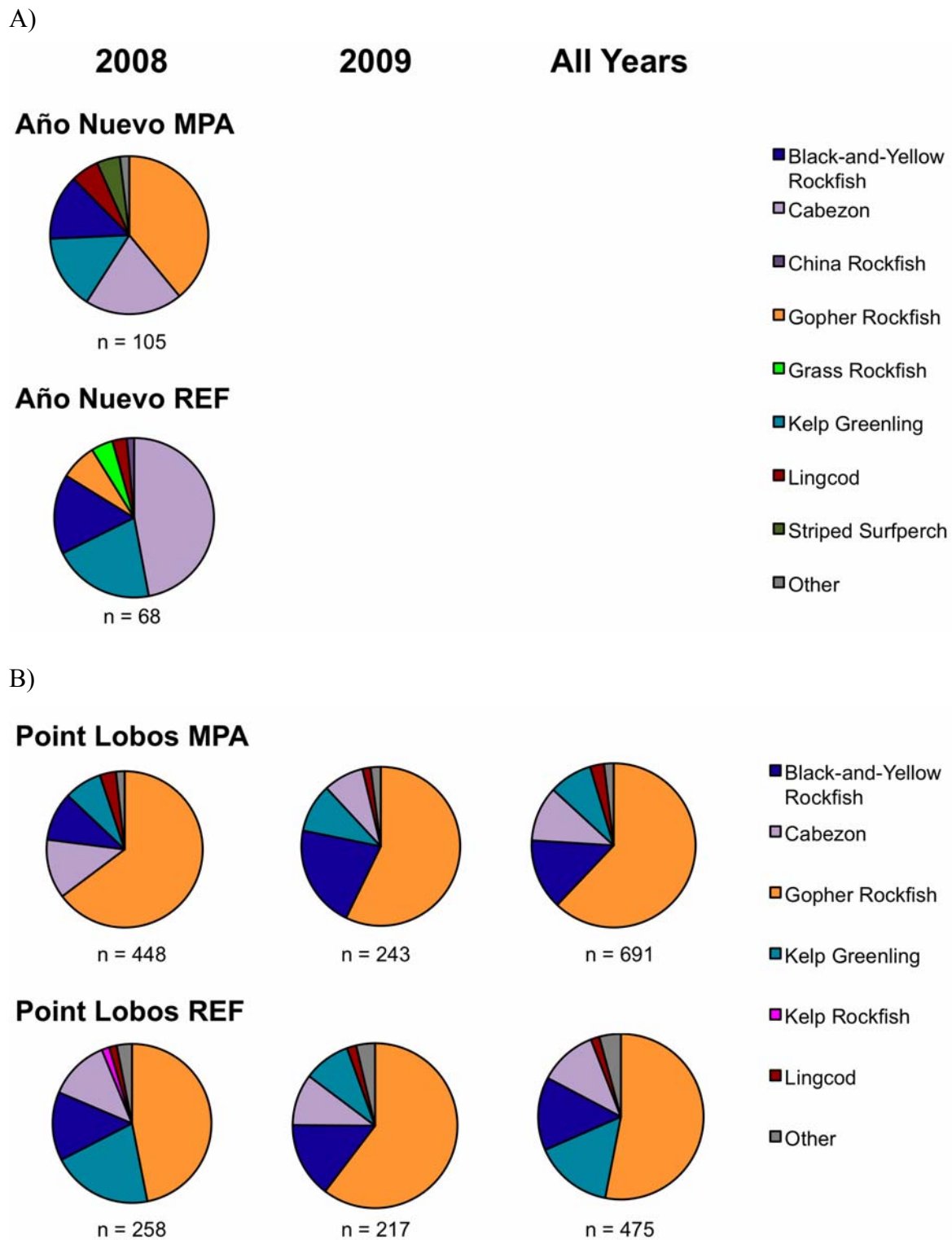

Figure 8. Species composition of trap gear surveys. Pie charts show comparisons between the Marine Protected Area (MPA) and reference site (REF) at A) Año Nuevo, and B) Point Lobos. All pie charts show species comprising 1.5% or greater of the total catch. Species comprising less than 1.5% of the total are grouped as “Other”.

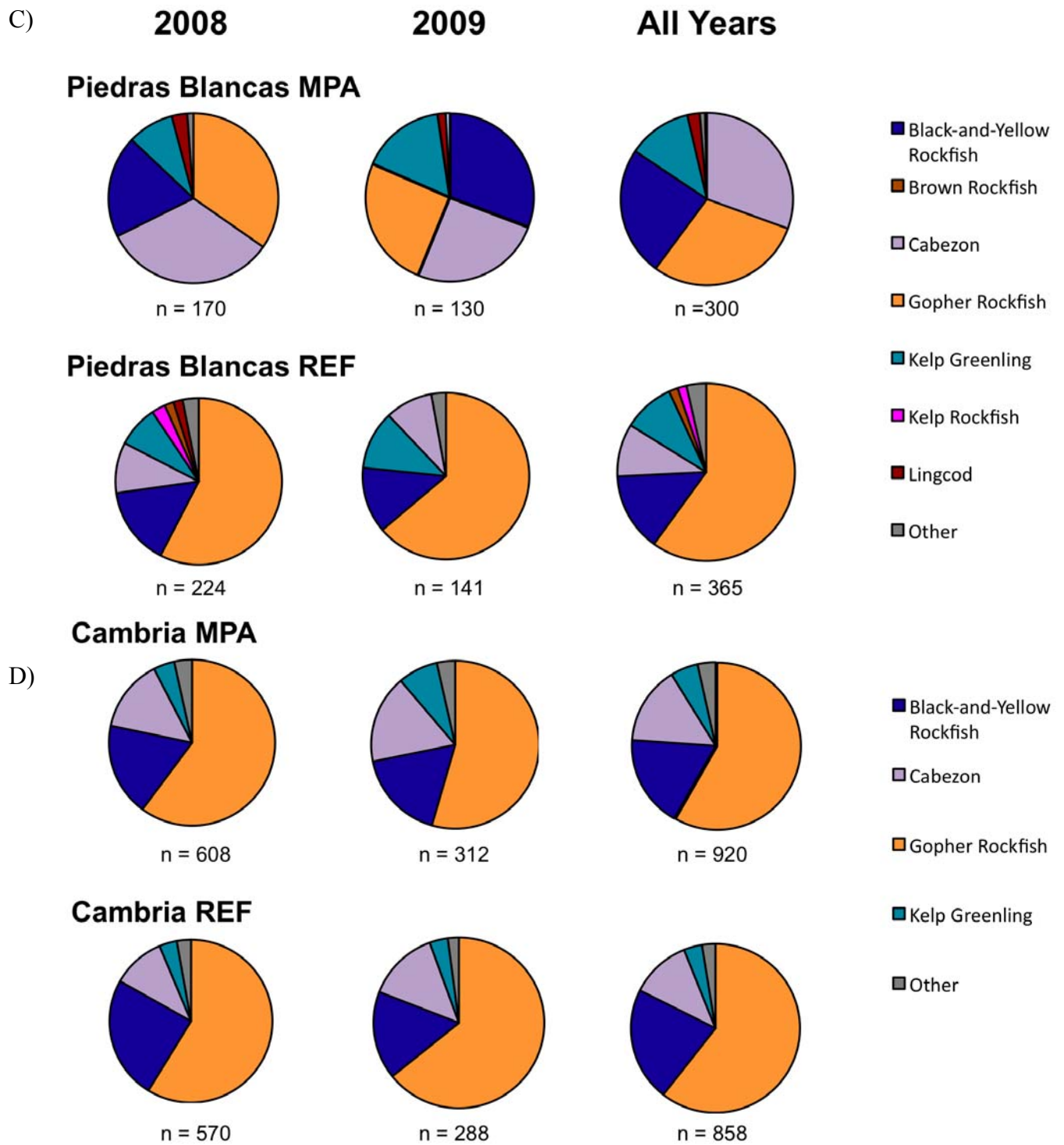
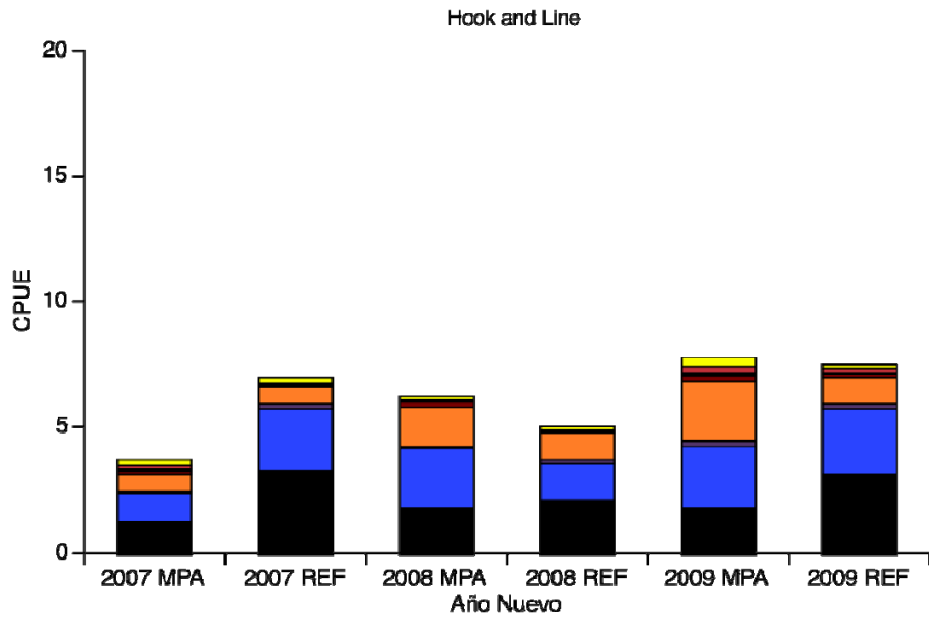

Figure 8 cont. Species composition of trap gear surveys. Pie charts show comparisons between the Marine Protected Area (MPA) and reference site (REF) at C) Piedras Blancas, and D) Cambria. All pie charts show species comprising 1.5% or greater of the total catch. Species comprising less than 1.5% of the total are grouped as “Other”.

A)



B)

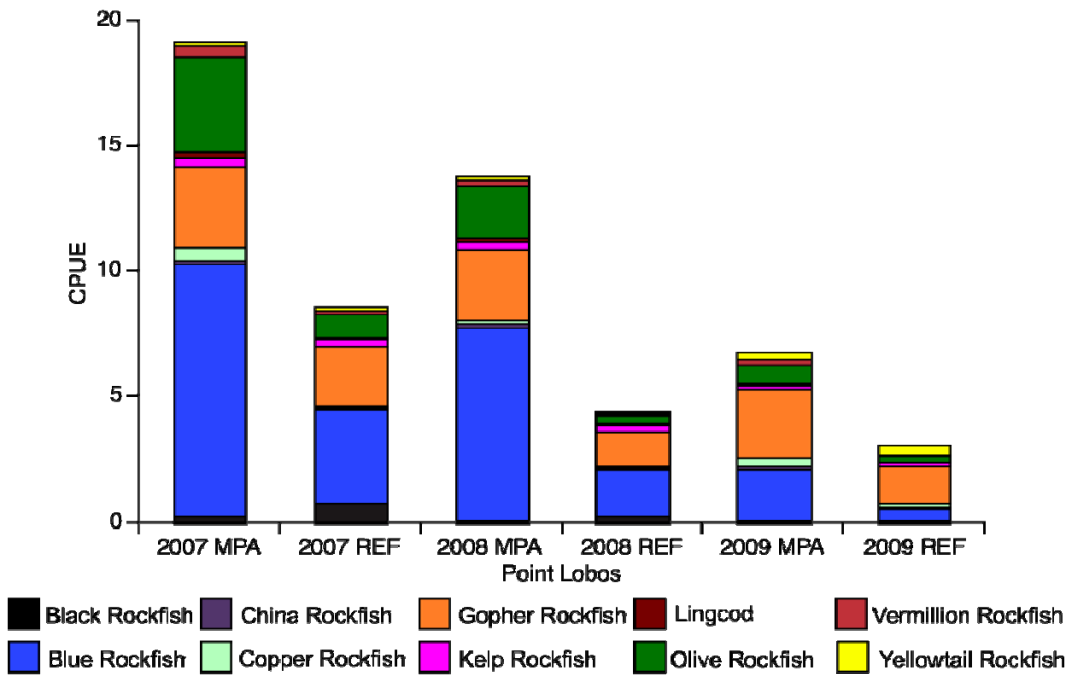

Figure 9. Total catch per angler hour (CPUE) (total catch of each species / total angler hours fished) of the ten most frequently caught species using hook and line in the A) Año Nuevo (AN), B) Point Lobos (PL), C) Piedras Blancas (BL), and D) Point Buchon (PB) areas.

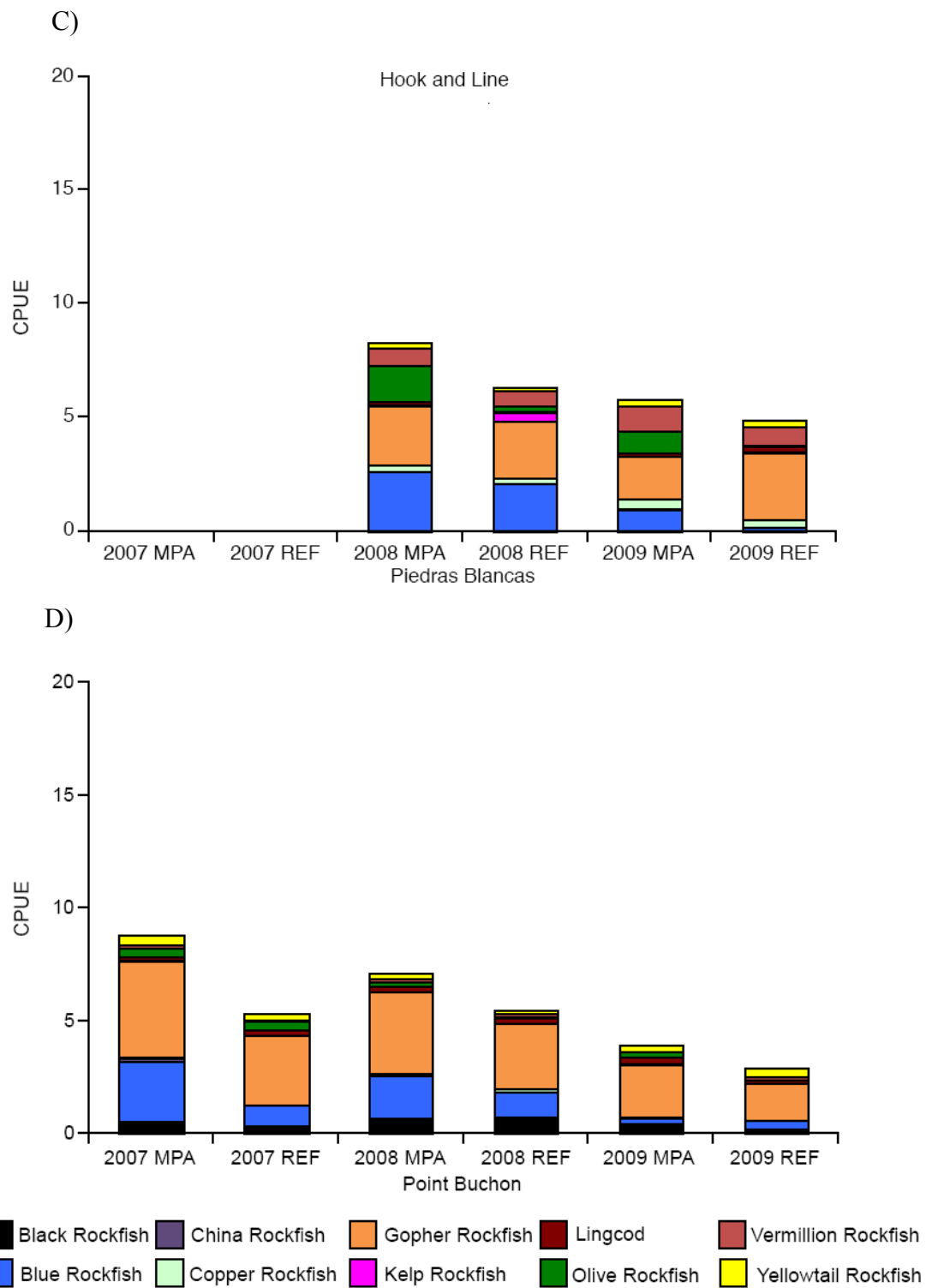

Figure 9 cont. Total catch per angler hour (CPUE) (total catch of each species / total angler hours fished) of the ten most frequently caught species using hook and line in the A) Año Nuevo (AN), B) Point Lobos (PL), C) Piedras Blancas (BL), and D) Point Buchon (PB) areas.

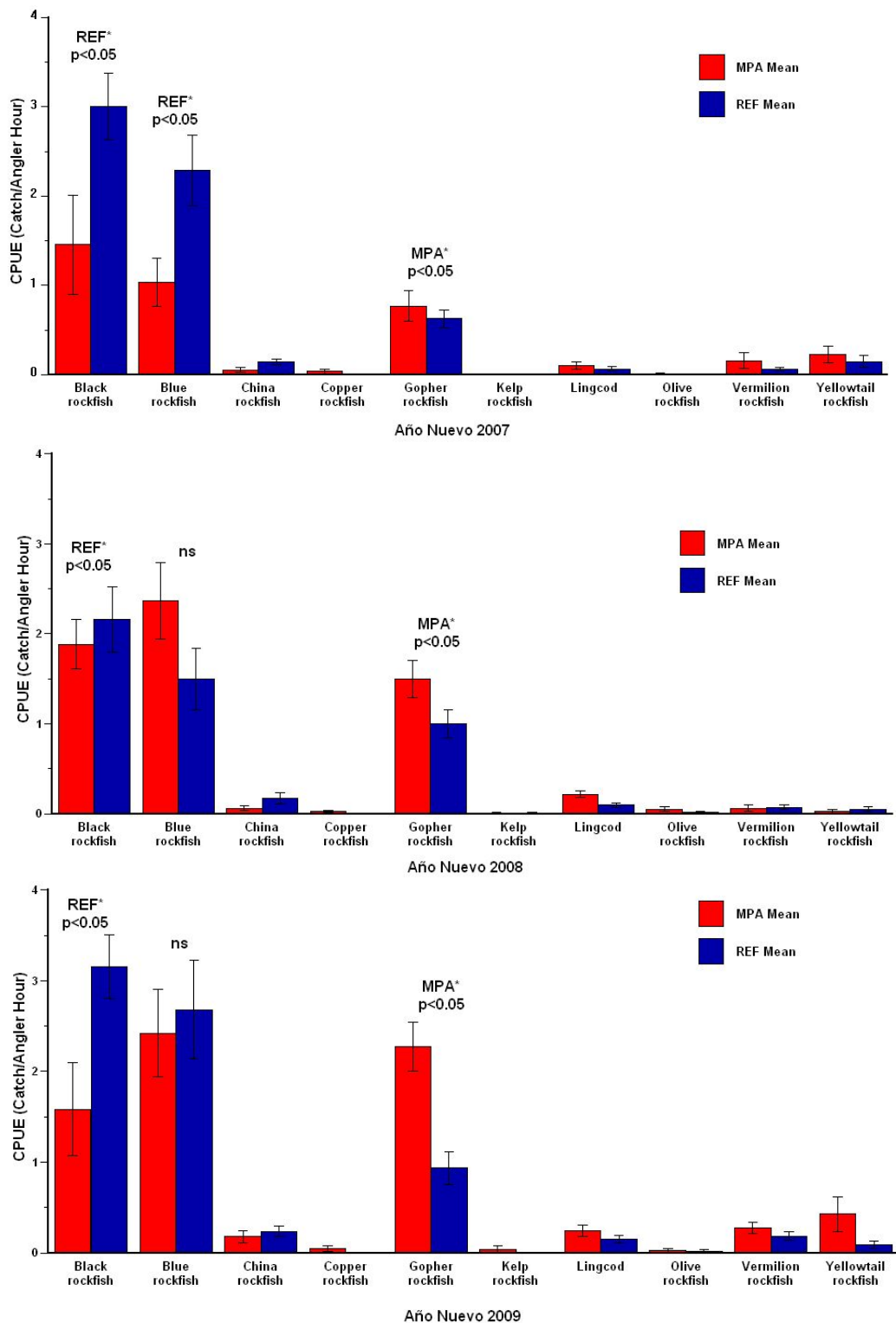

Figure 10. Average catch per angler hour (mean CPUE \pm SE) of the ten species most frequently caught with hook-and-line gear in Año Nuevo. Only black, blue, and gopher rockfishes data could be tested. Significant differences between sites and years were determined using a two-factor Model I ANOVA. Significant differences between sites are indicated with asterisks (*) and p-values. Gopher rockfish were caught at significantly lower rates in 2007 than 2008 and 2009, while 2008 and 2009 catch rates were not significantly different. No annual differences in black and blue rockfish catch rates were observed.

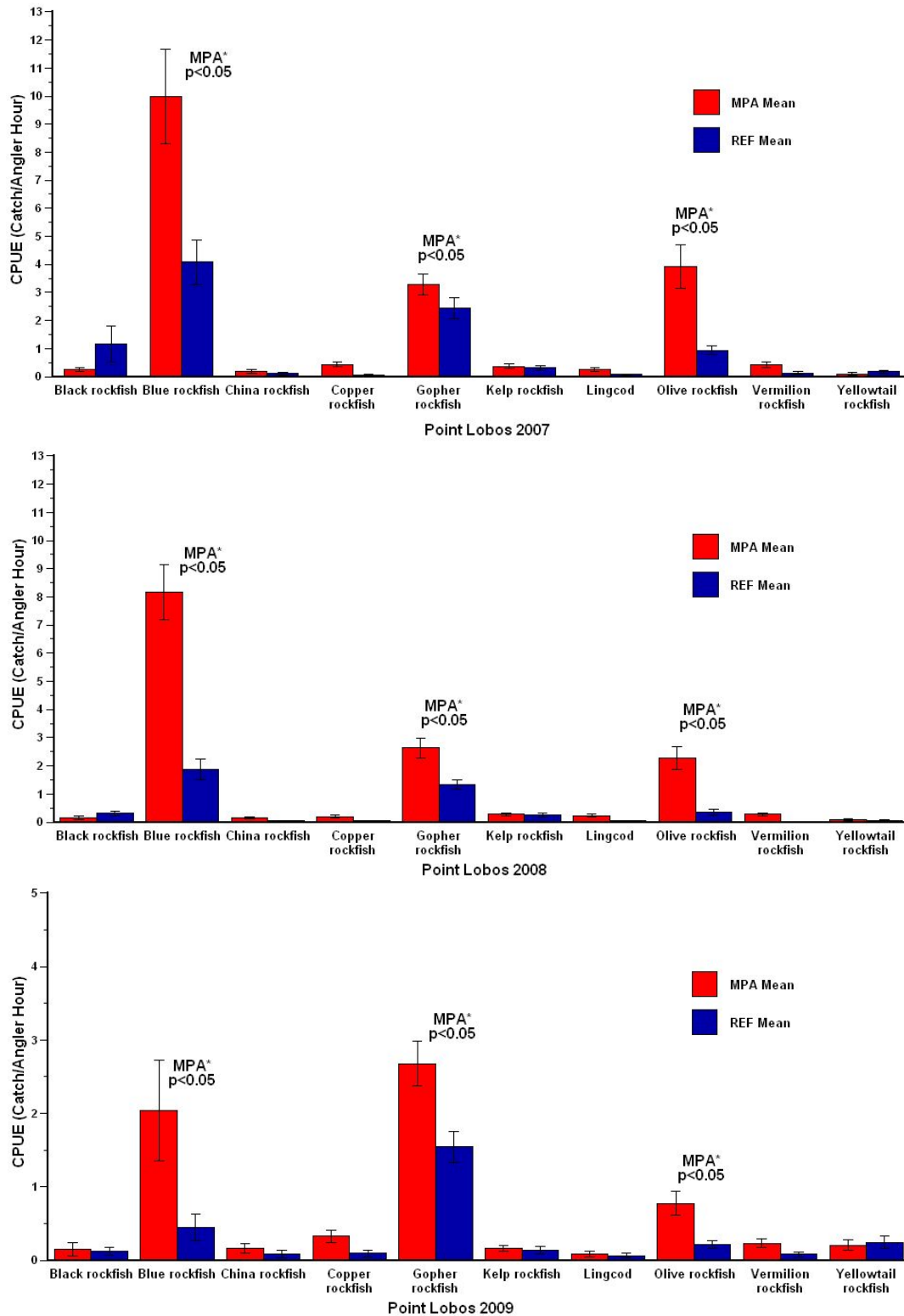

Figure 11. Average catch per angler hour (mean CPUE \pm SE) of the ten species most frequently caught with hook-and-line gear in Point Lobos. Only blue, gopher, and olive rockfishes data could be tested. Significant differences between sites and years were determined using a two-factor Model I ANOVA. Significant differences are indicated with asterisks (*) and p-values.

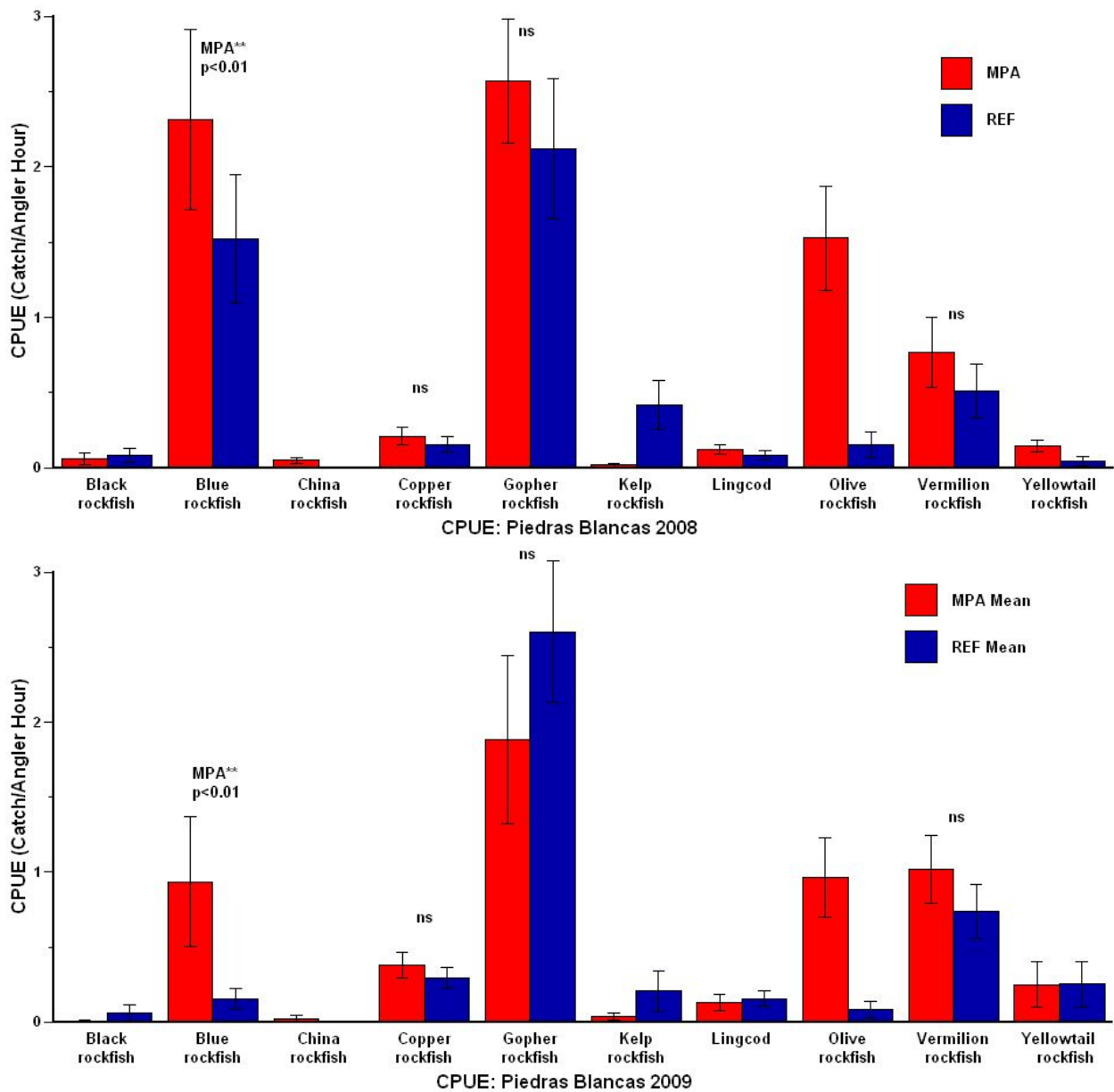

Figure 12. Average catch per angler hour (mean CPUE \pm SE) of the ten species most frequently caught with hook-and-line gear in Piedras Blancas. Only blue, gopher, and vermilion rockfishes data could be tested. Significant differences between sites and years were determined using a two-factor Model I ANOVA. Significant differences between sites are indicated with asterisks (*) and p-values.

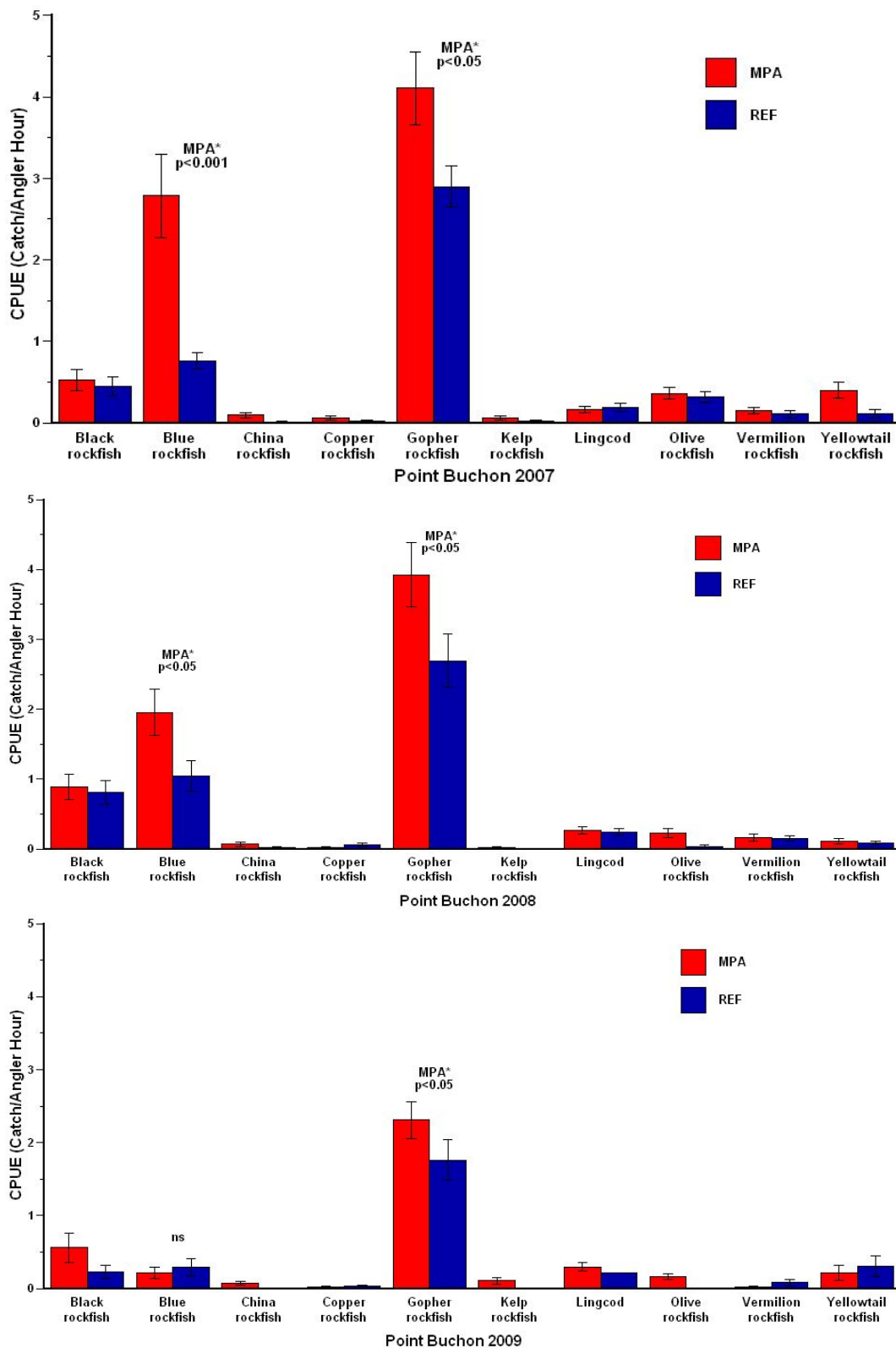

Figure 13. Average catch per angler hour (mean CPUE \pm SE) of the ten species most frequently caught with hook-and-line gear in Point Buchon. Only blue and gopher rockfishes data could be tested. Significant differences between sites and years were determined using a two-factor Model I ANOVA. Significant differences are indicated with asterisks (*) and p-values.

Hook and Line

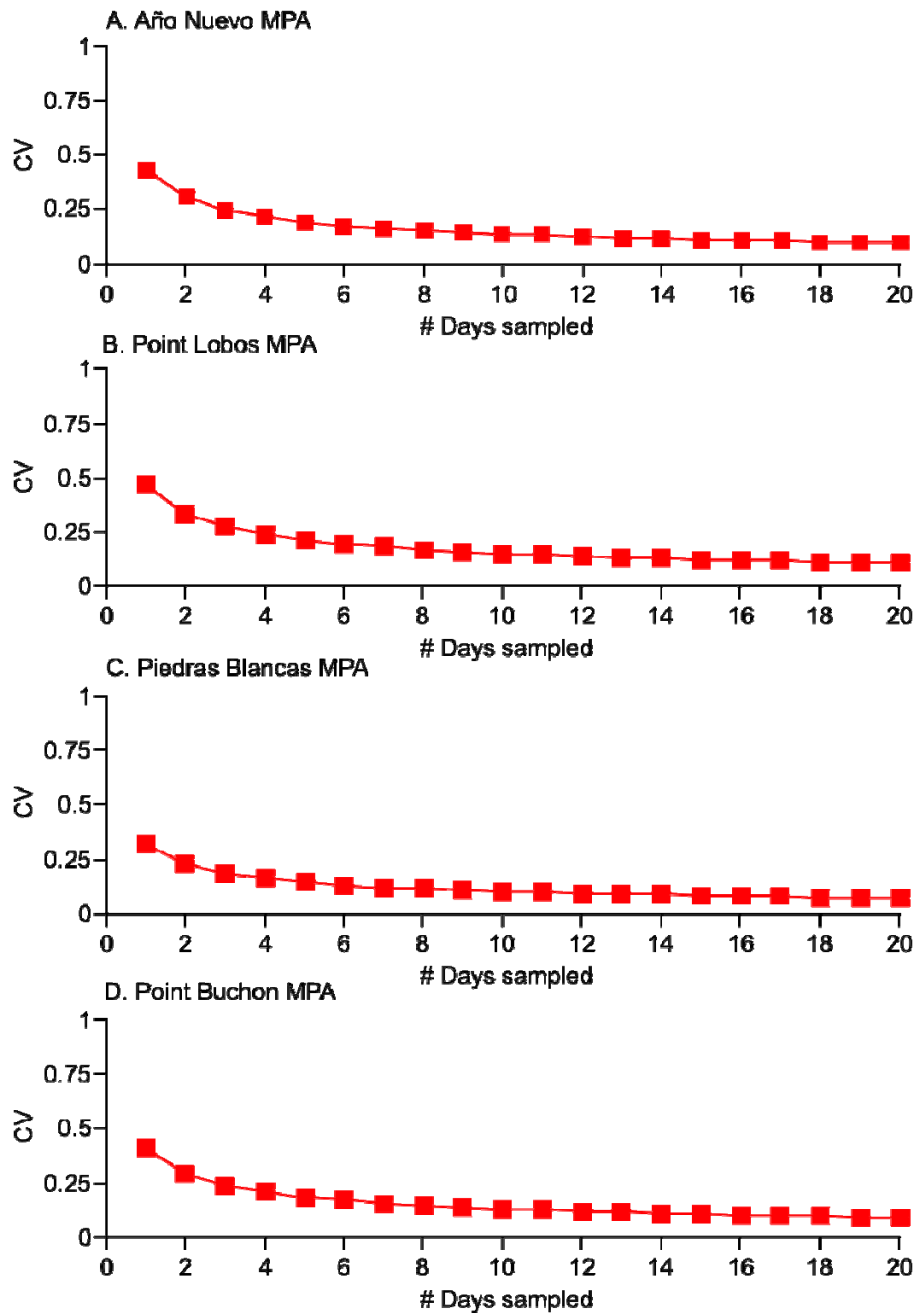
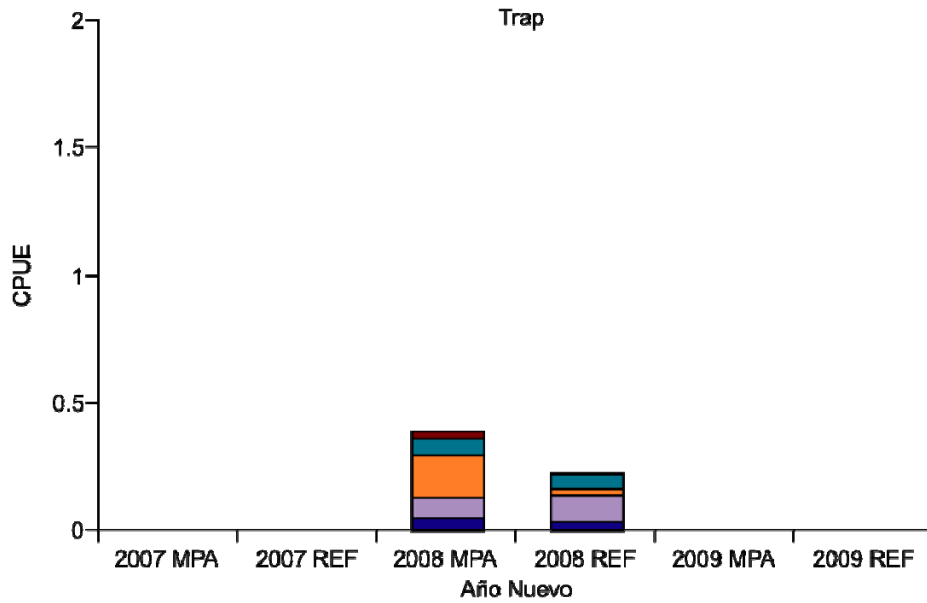

Figure 14. Coefficient of variance (CV) generated from resampling actual catch per day (CPUE) for all species caught using hook and line in the Año Nuevo, Point Lobos, Piedras Blancas, and Point Buchon MPAs. Resampling Stats 6.0 was used to generate mean and standard deviations (50,000 iterations) used to calculate CV at increasing levels of sampling effort (1-20 days).

A)



B)

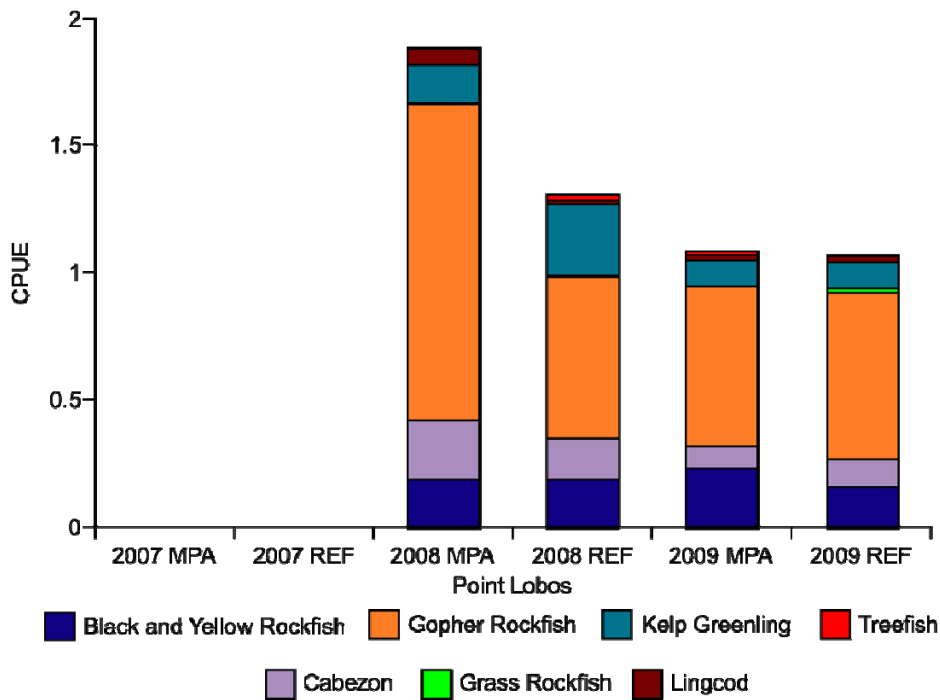

Figure 15. Total catch per trap hour (CPUE) (total catch of each species / total trap hours fished) of the ten most frequently caught species using hook and line in the A) Año Nuevo (AN), B) Point Lobos (PL), C) Piedras Blancas (BL), and D) Point Buchon (PB) areas.

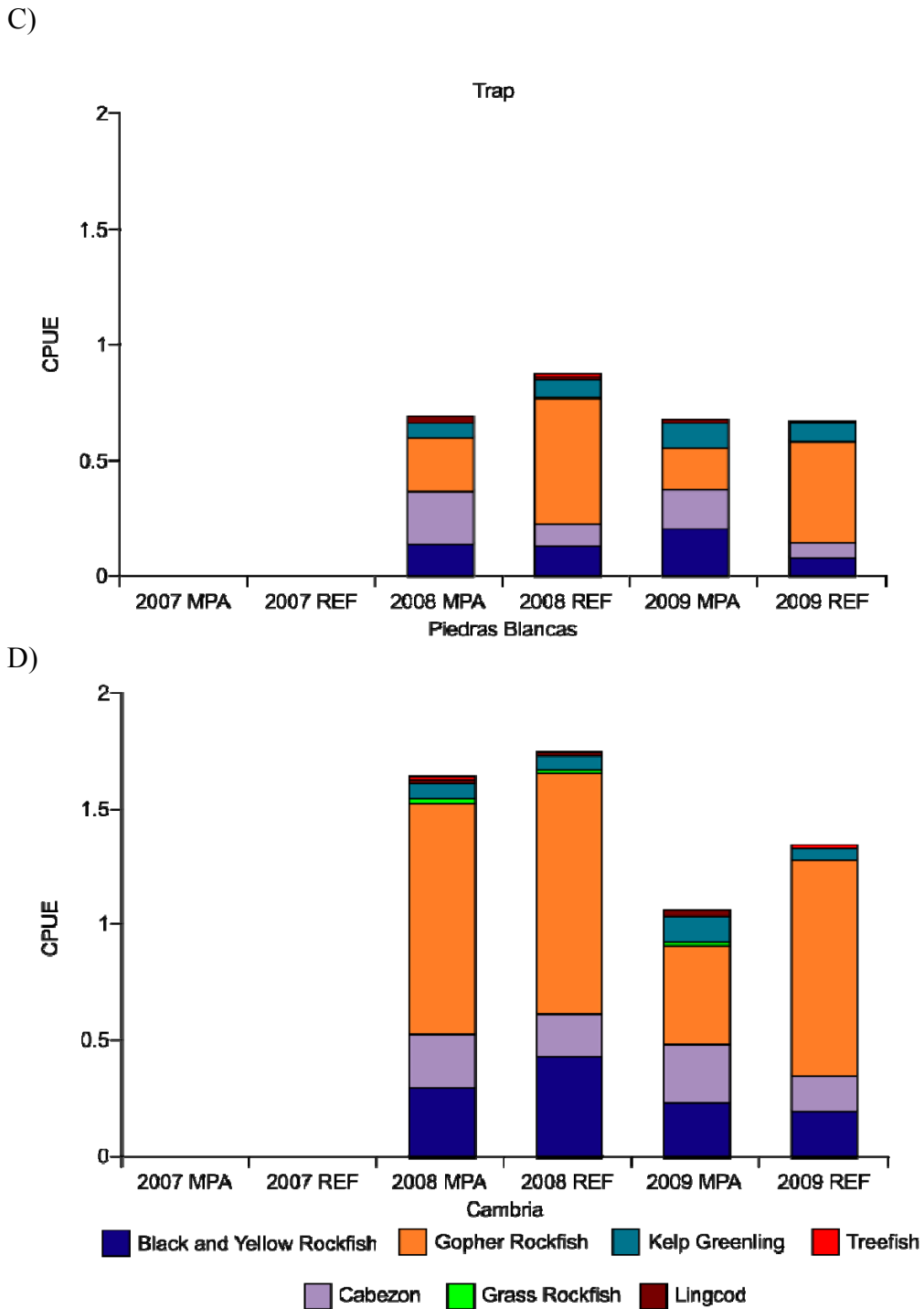

Figure 15 cont. Total catch per trap hour (CPUE) (total catch of each species / total trap hours fished) of the ten most frequently caught species using hook and line in the A) Año Nuevo (AN), B) Point Lobos (PL), C) Piedras Blancas (BL), and D) Point Buchon (PB) areas.

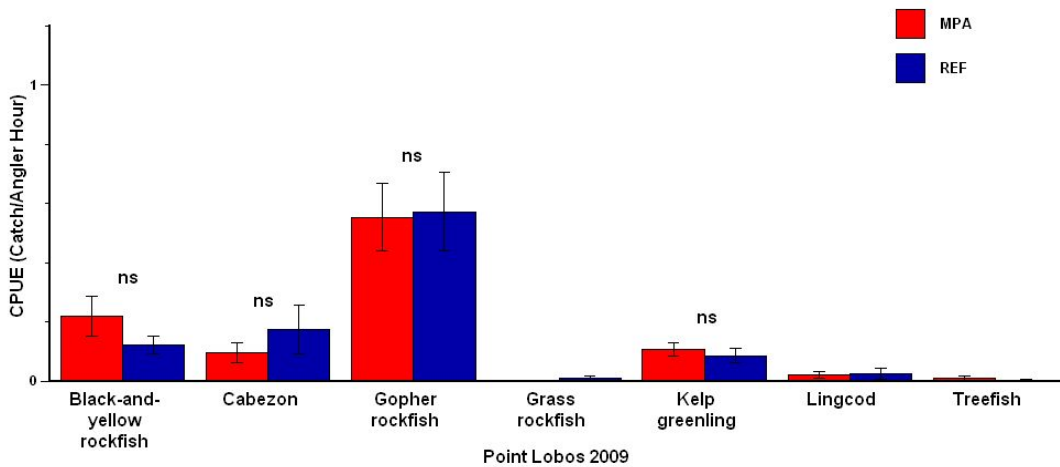
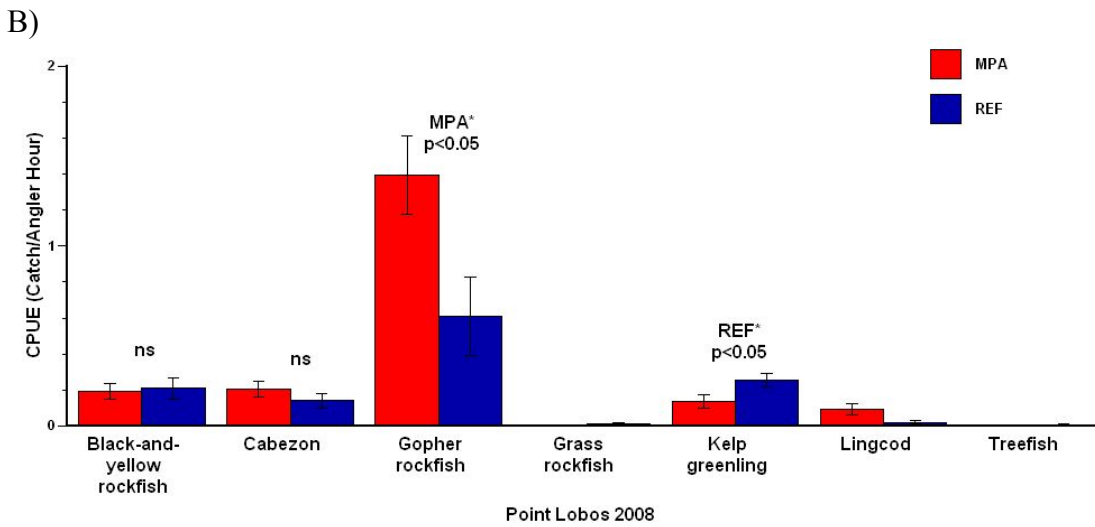
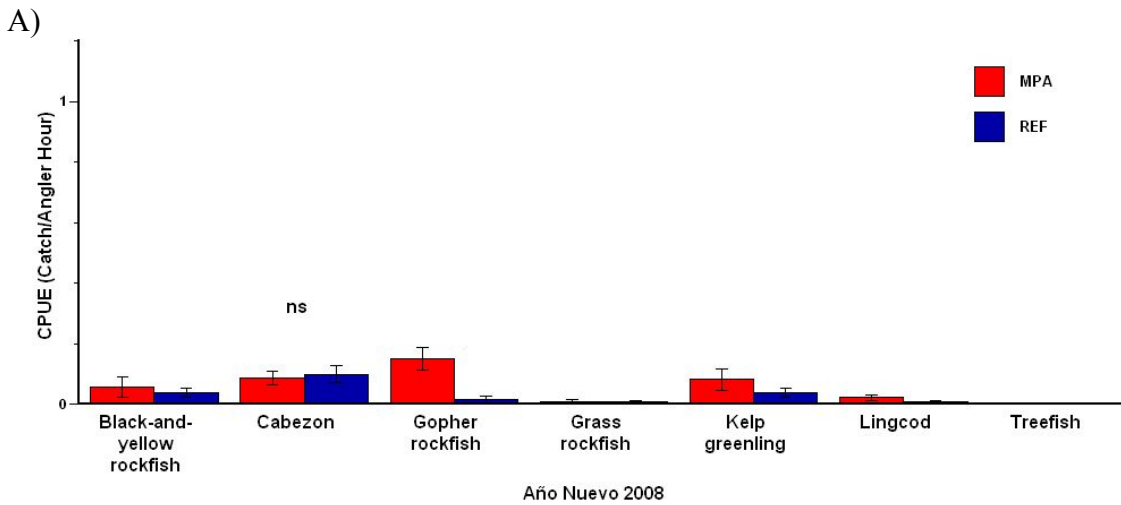

Figure 16. Average catch per trap hour (mean CPUE \pm SE) of the seven most frequently caught species with trap gear in A) Año Nuevo, and B) Point Lobos. Significant differences are indicated with asterisks (*) and p-values.

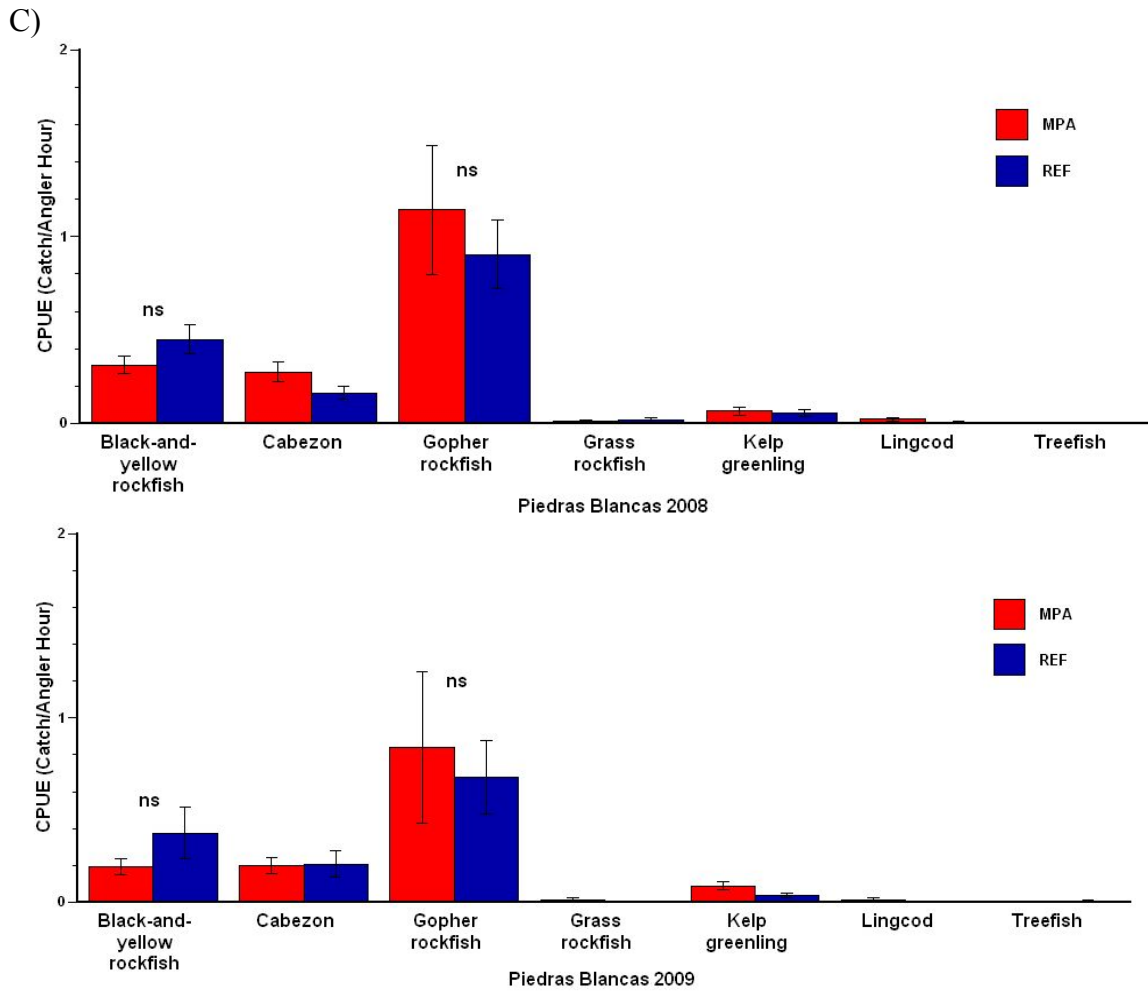

Figure 16 cont. Average catch per trap hour (mean CPUE \pm SE) of the seven most frequently caught species with trap gear in C) Piedras Blancas. Significant differences are indicated with asterisks (*) and p-values.

D)

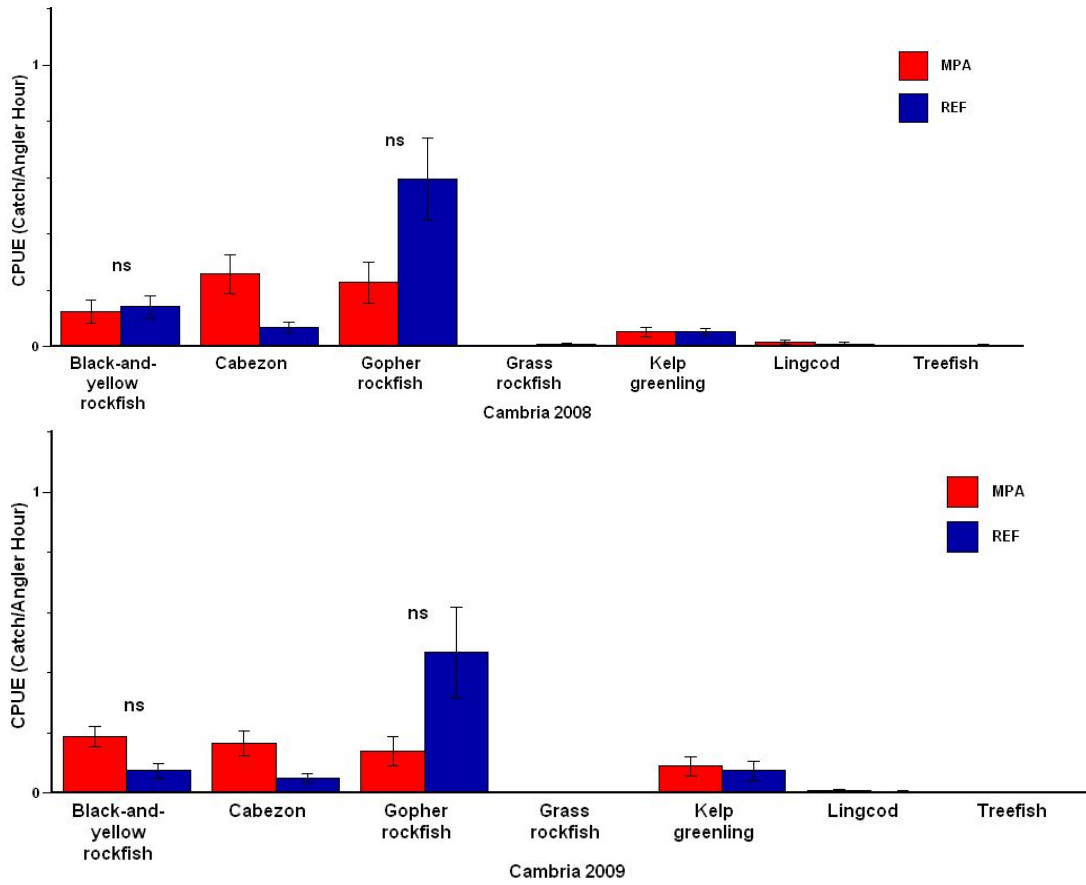

Figure 16 cont. Average catch per trap hour (mean CPUE \pm SE) of the seven most frequently caught species with trap gear in D) Cambria. Significant differences are indicated with asterisks (*) and p-values.

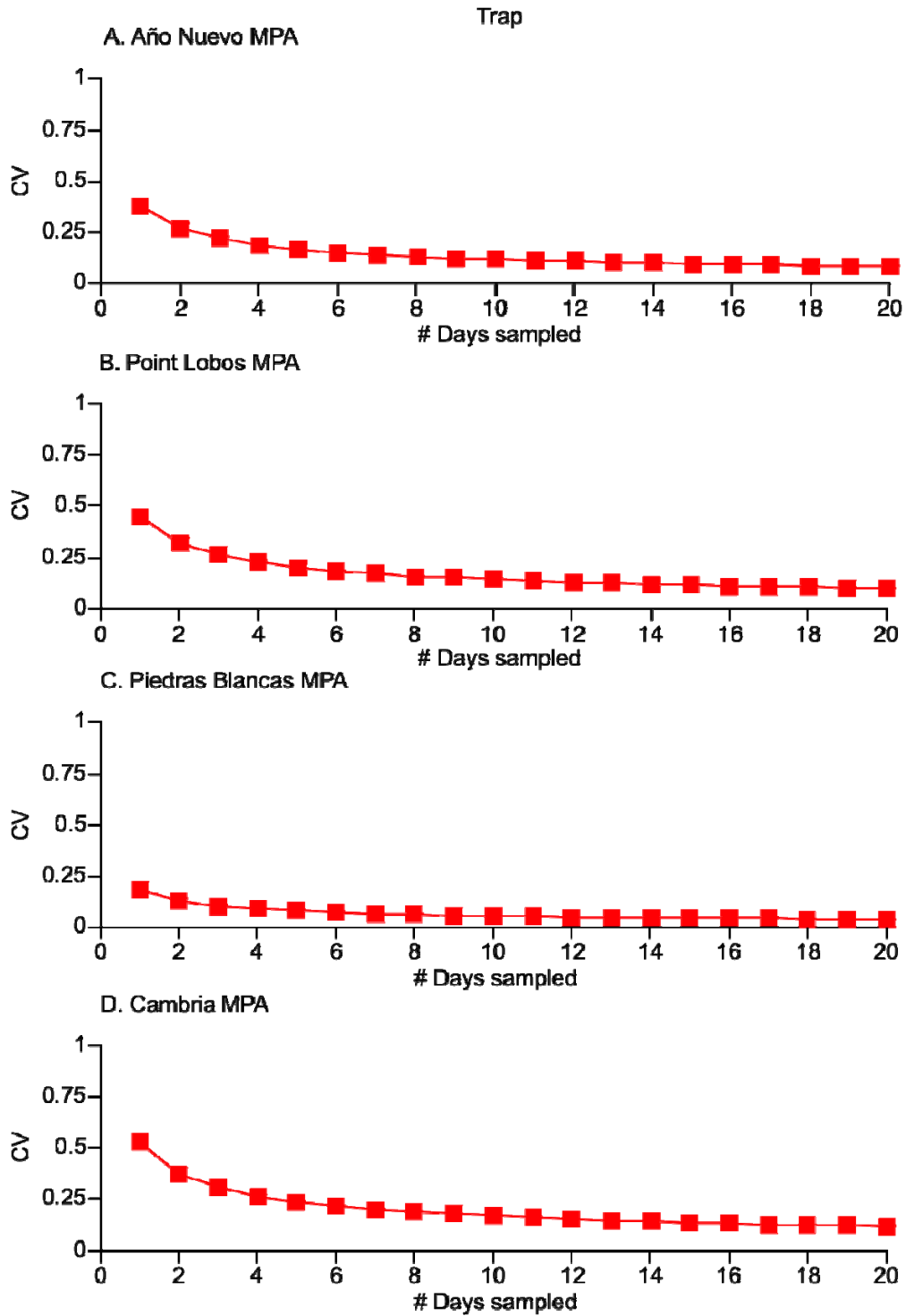

Figure 17. Coefficient of variance (CV) generated from resampling actual catch per day (CPUE) for all species caught using traps in the Año Nuevo, Point Lobos, Piedras Blancas, and Cambria MPAs. Resampling Stats 6.0 was used to generate mean and standard deviations (50,000 iterations) used to calculate CV at increasing levels of sampling effort (1-20 days).

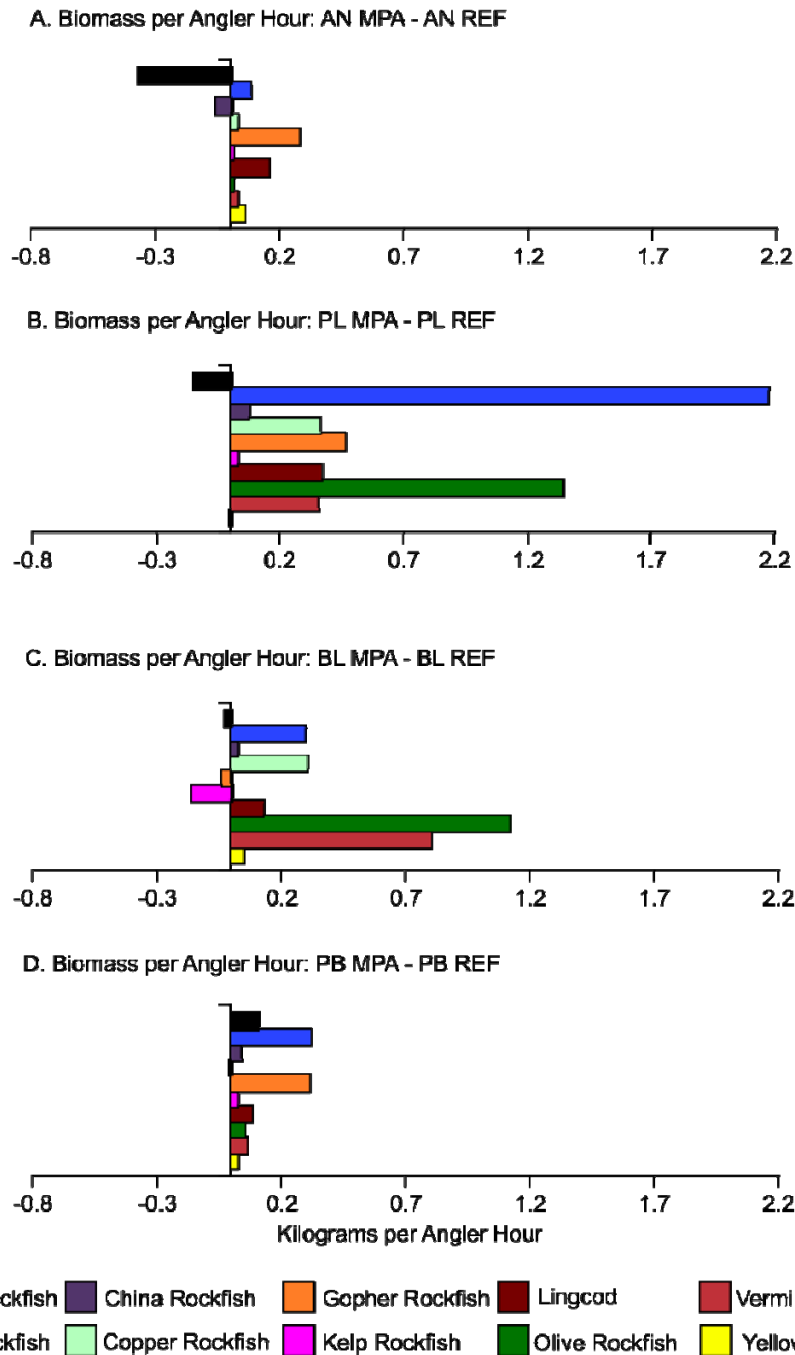

Figure 18. The difference in the average biomass per angler hour in kilograms between sites (Marine Protected Area (MPA) minus reference site (REF)) in A. Año Nuevo (AN), B. Point Lobos (PL), C. Piedras Blancas (BL), and D. Point Buchon (PB) for the ten most frequently caught species using hook and line. All study years are combined.

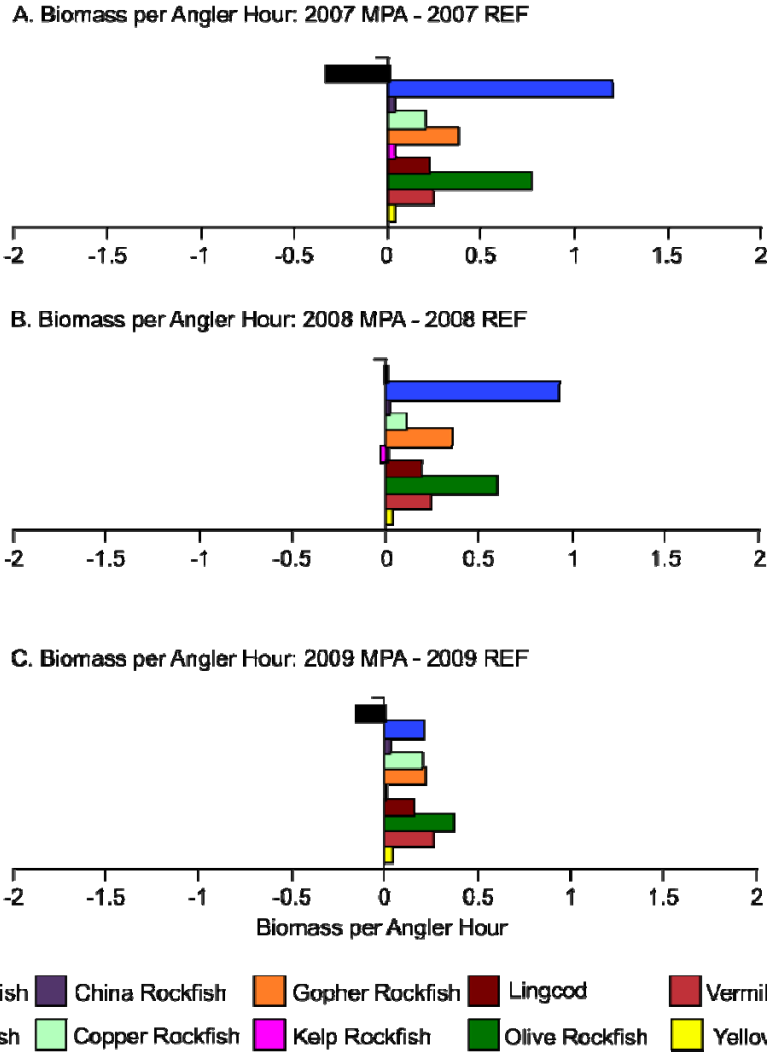

Figure 19. The difference in the average biomass per angler hour in kilograms (Marine Protected Area (MPA) minus reference site (REF)) between years fished in A. 2007, B. 2008, and C. 2009 for the ten most frequently caught species using hook and line gear. All study areas are combined.

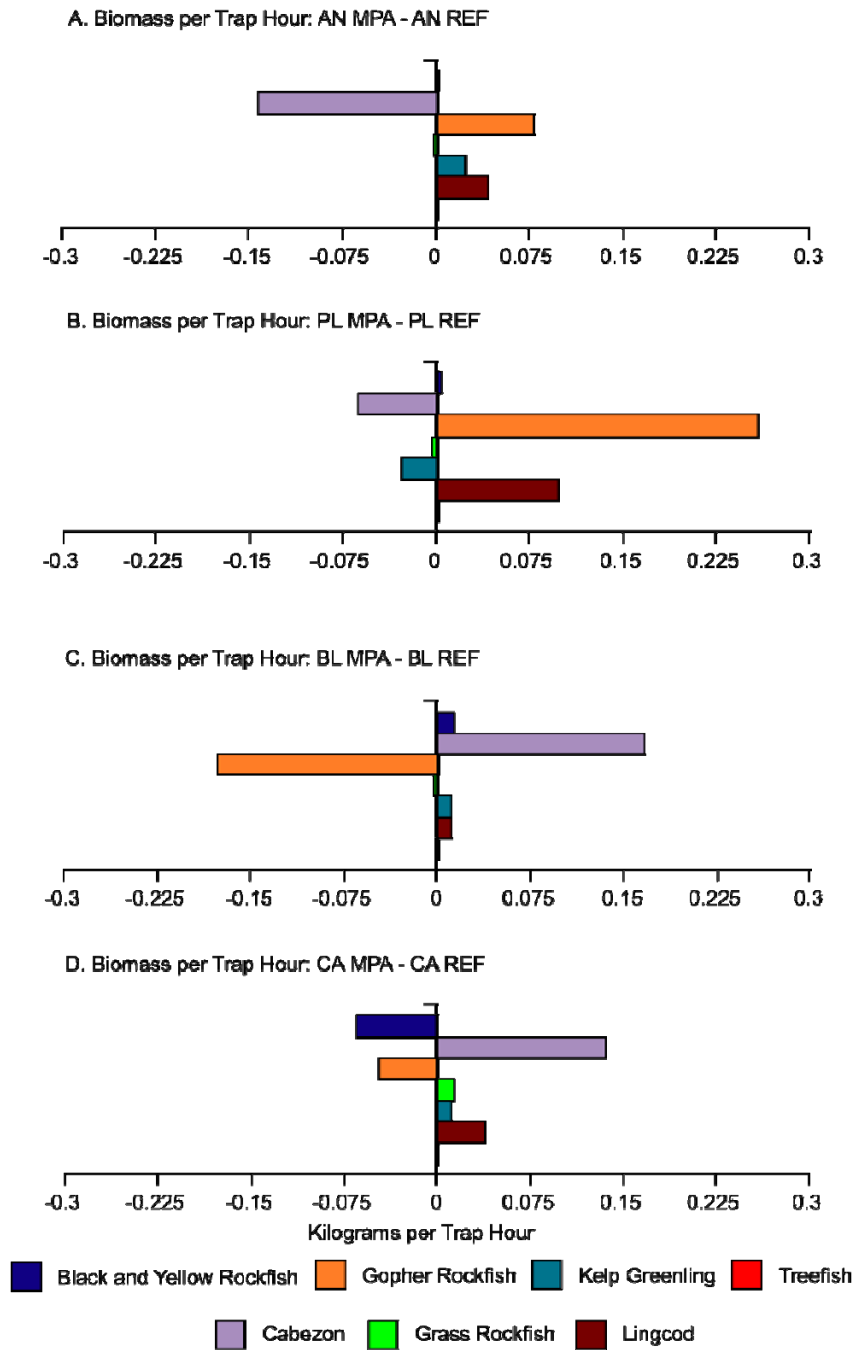

Figure 20. The difference in the average biomass per trap hour in kilograms between sites (Marine Protected Area (MPA) minus reference site (REF)) in A. Año Nuevo (AN), B. Point Lobos (PL), C. Piedras Blancas (BL), and D. Cambria (CA) for the seven most frequently caught species using traps. All study years are combined.

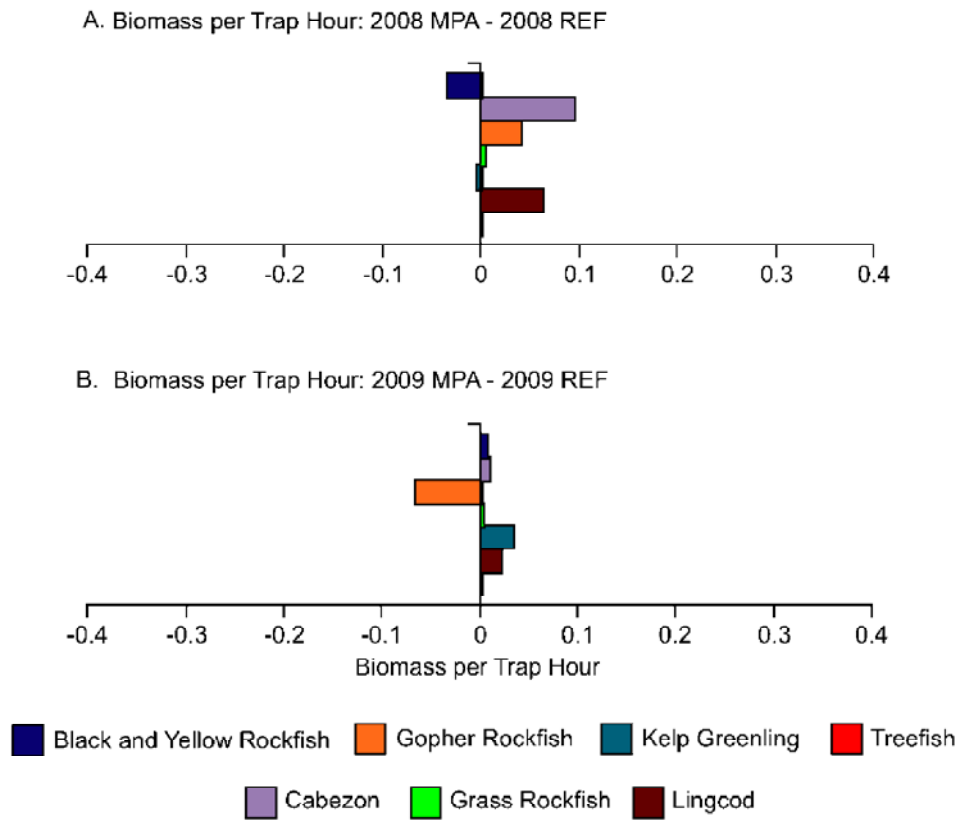
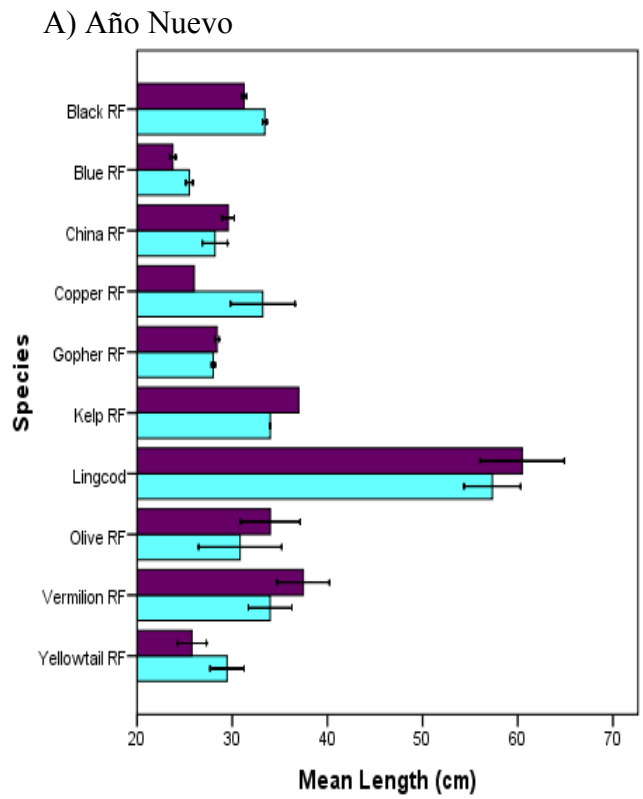
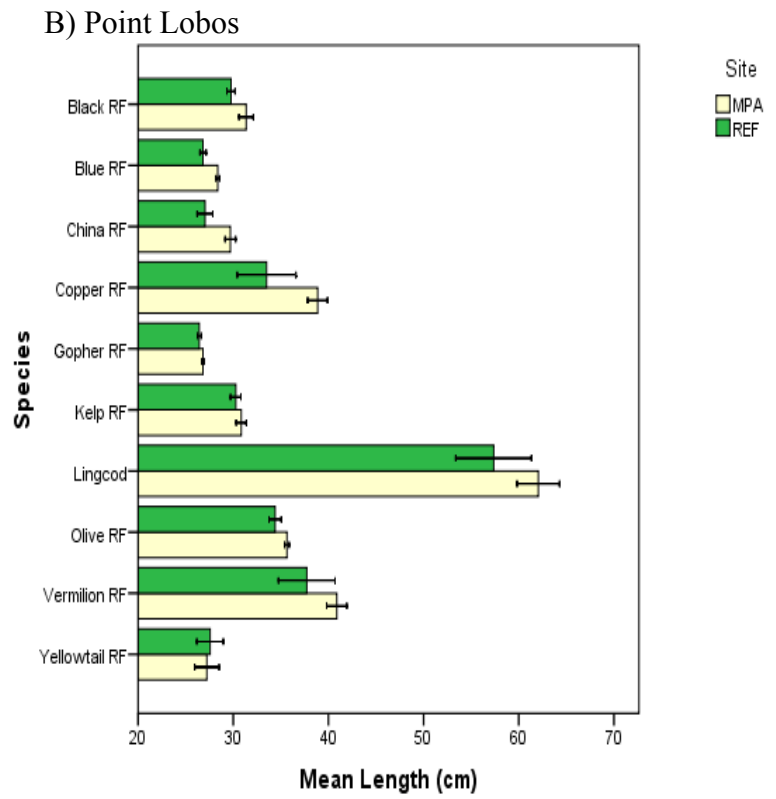

Figure 21. The difference in the average biomass per trap hour in kilograms (Marine Protected Area (MPA) minus reference site (REF)) between years fished in A. 2008, and B. 2009 for the seven most frequently caught species using trap gear. All study areas are combined.



Error Bars: +/- 2 SE



Error Bars: +/- 2 SE

Figure 22. Mean lengths of the ten most commonly caught species using hook-and-line gear in each area, in MPA and REF sites, all sampling years combined, for A) Año Nuevo, B) Point Lobos, C) Piedras Blancas, and D) Point Buchon.

C) Piedras Blancas

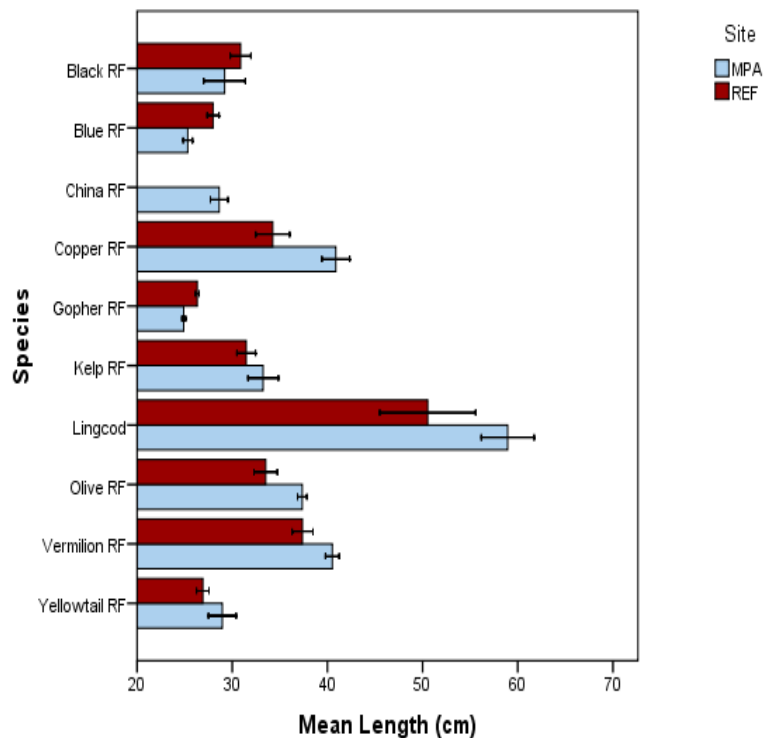

Error Bars: +/- 2 SE

D) Point Buchon

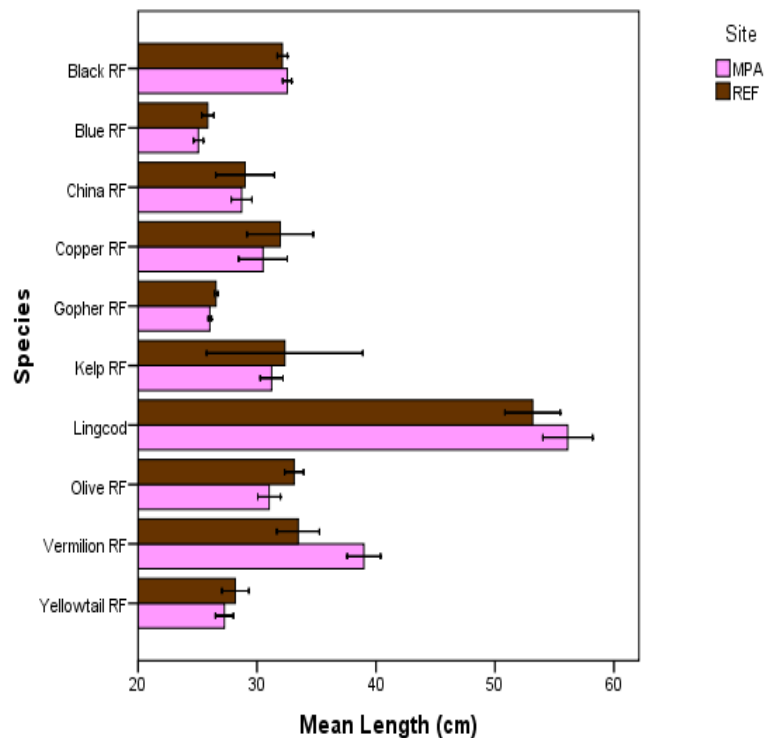

Error Bars: +/- 2 SE

Figure 22 cont. Mean lengths of the ten most commonly caught species using hook-and-line gear in each area, in MPA and REF sites, all sampling years combined, for A) Año Nuevo, B) Point Lobos, C) Piedras Blancas, and D) Point Buchon.

A) Ano Nuevo

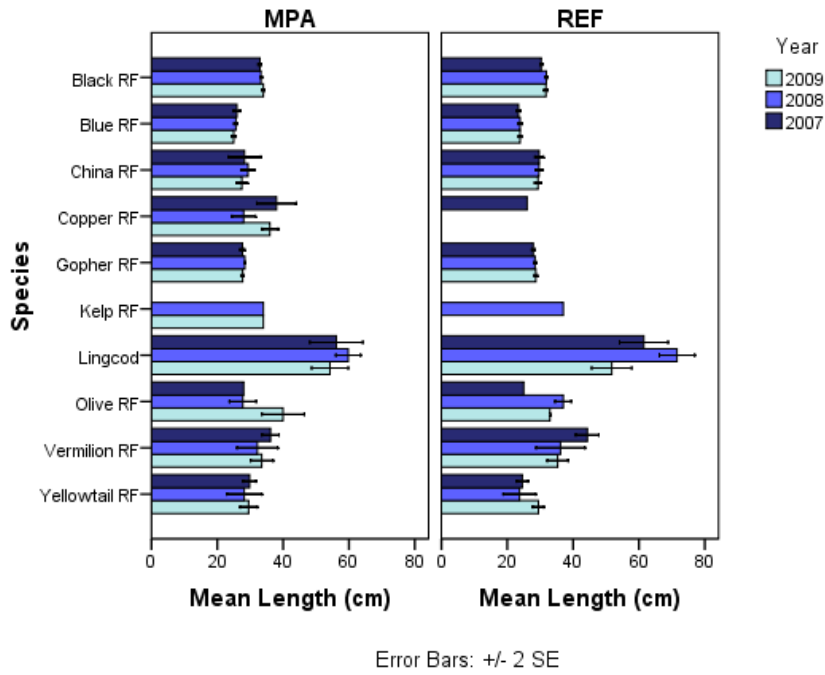

B) Point Lobos

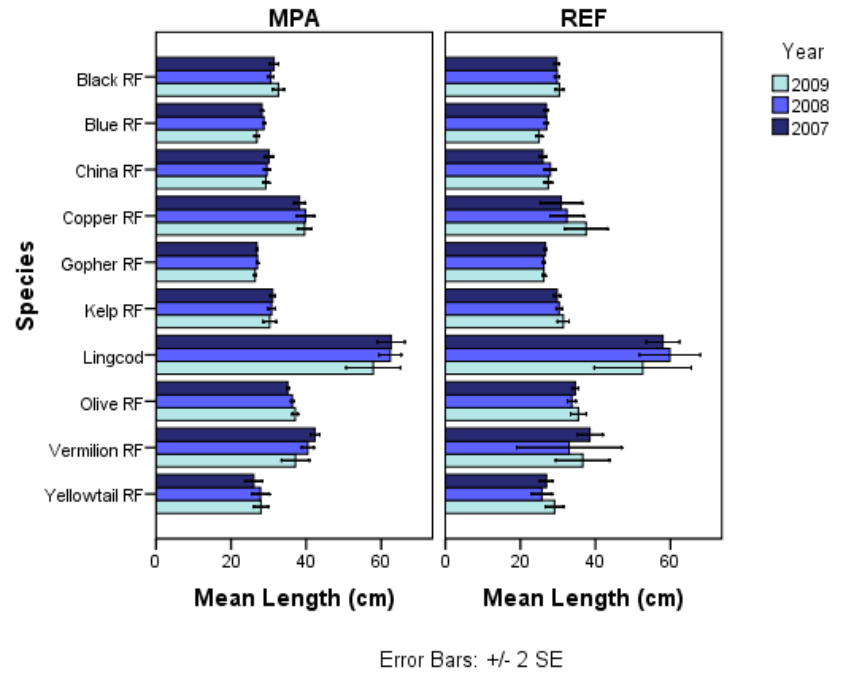

Figure 23. Mean lengths for each area and site, by year, for the top ten most frequently caught species with hook-and-line gear in A) Año Nuevo and B) Point Lobos.

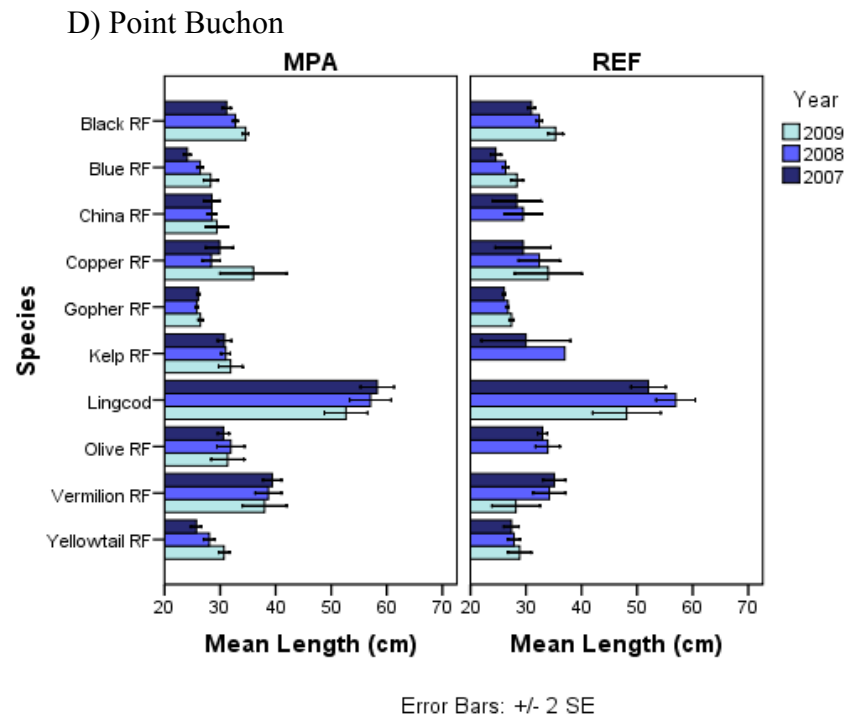
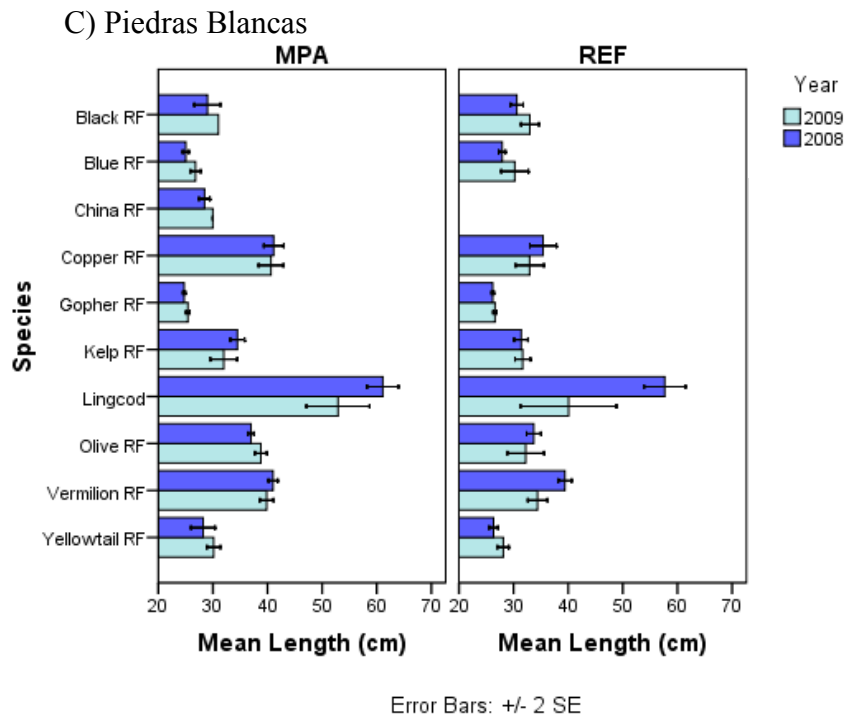
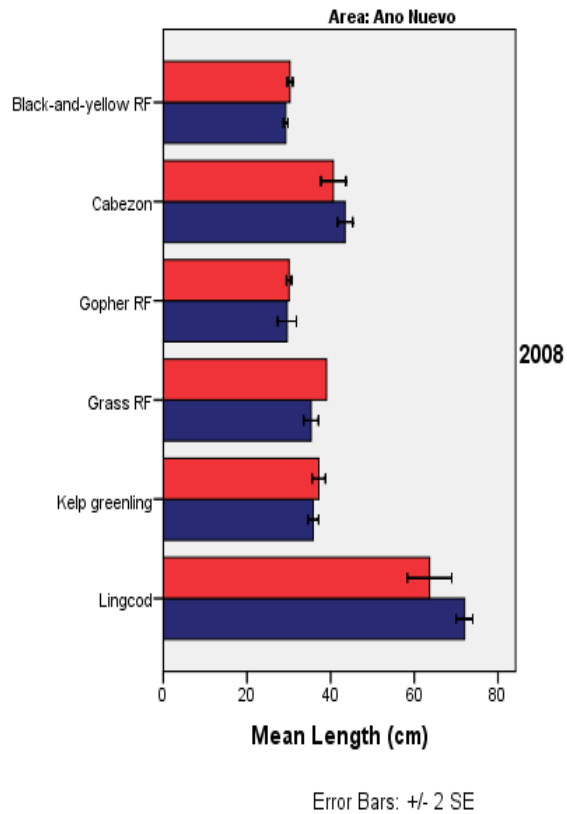

Figure 23 cont. Mean lengths for each area and site, by year, for the top ten most frequently caught species with hook-and-line gear in C) Piedras Blancas and D) Point Buchon.

A) Ano Nuevo



B) Point Lobos

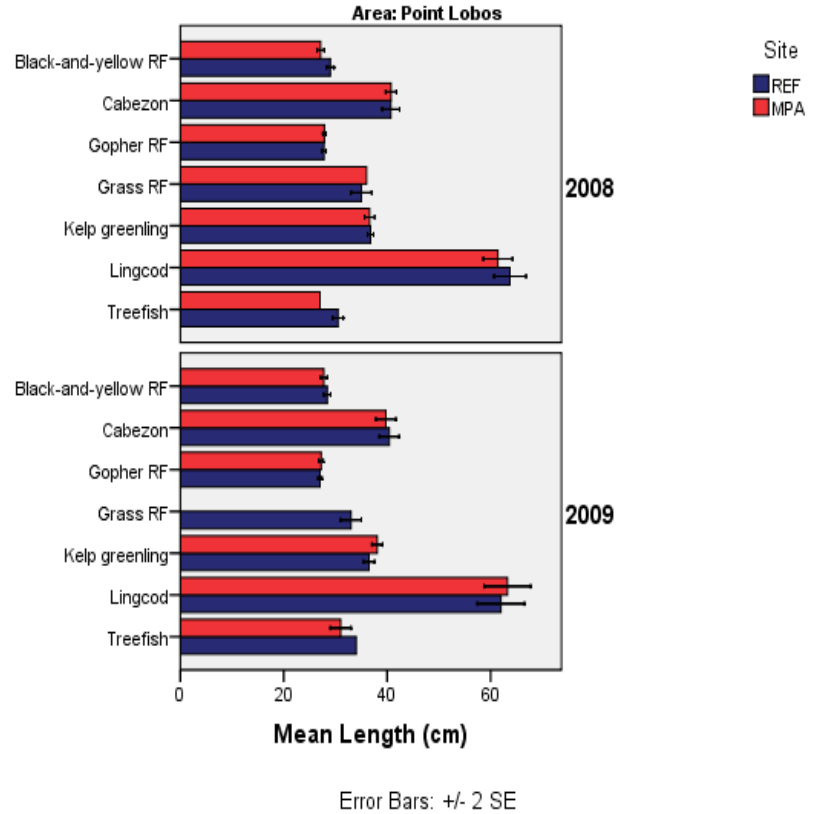
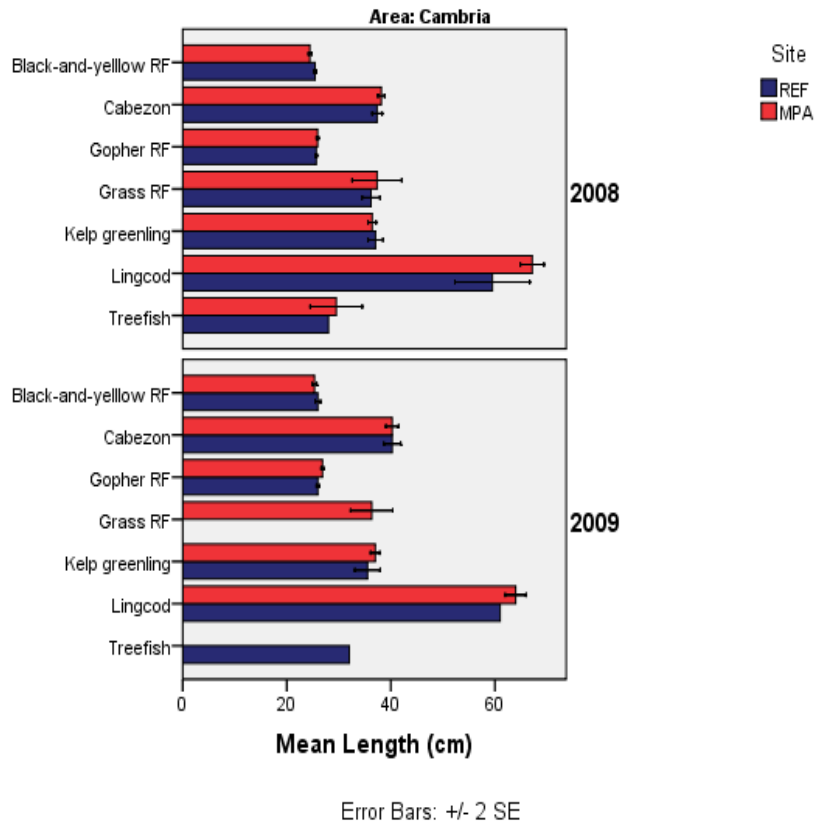

Figure 24. Mean lengths of the top seven most commonly caught species using trap gear in each area, comparing fish taken inside MPA and reference grid cells, 2008 & 2009 sampling years combined: A) Año Nuevo 2009 and B) Point Lobos.

C) Cambria



D) Piedras Blancas

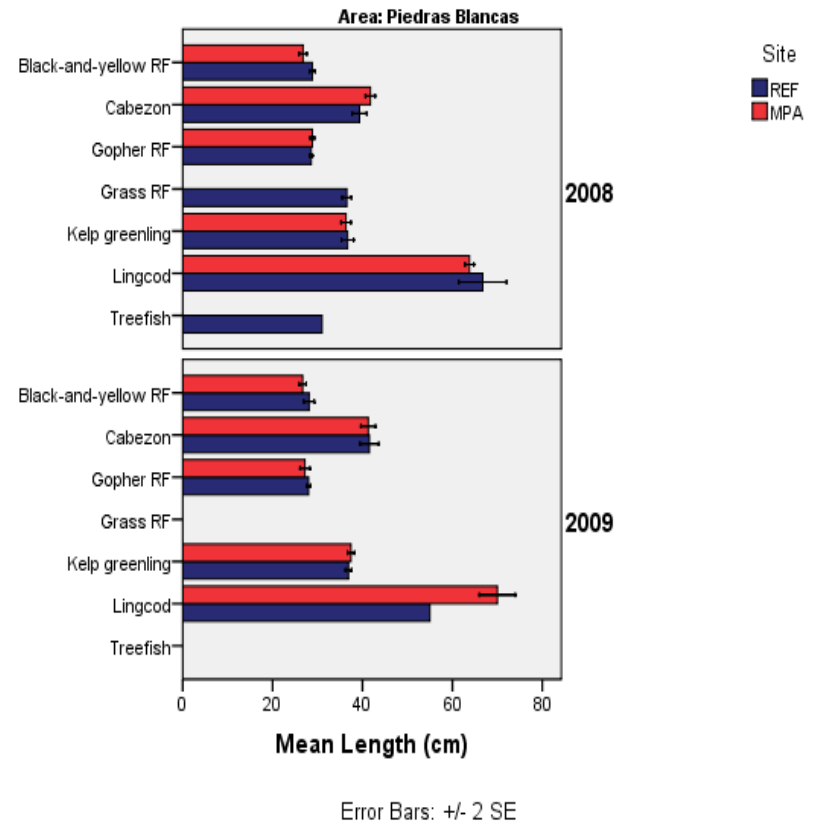
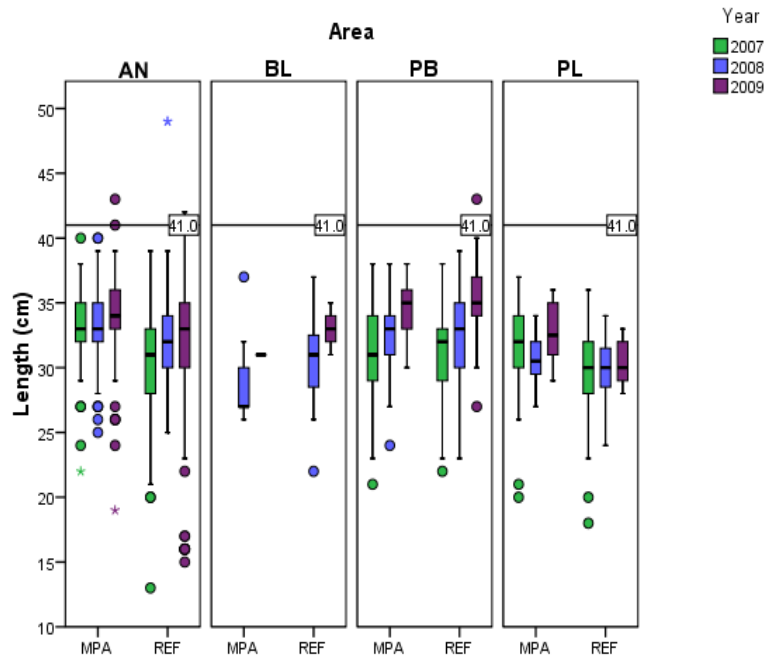

Figure 24 cont. Mean lengths of the top seven most commonly caught species using trap gear in each area, comparing fish taken inside MPA and reference grid cells, 2008 & 2009 sampling years combined: C) Cambria, and D) Piedras Blancas.

A) Black rockfish



B) Blue rockfish

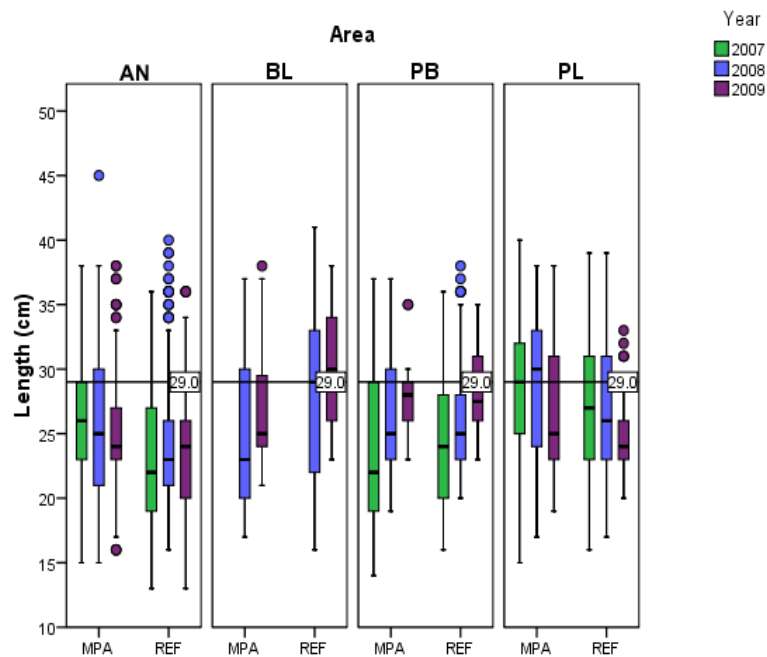
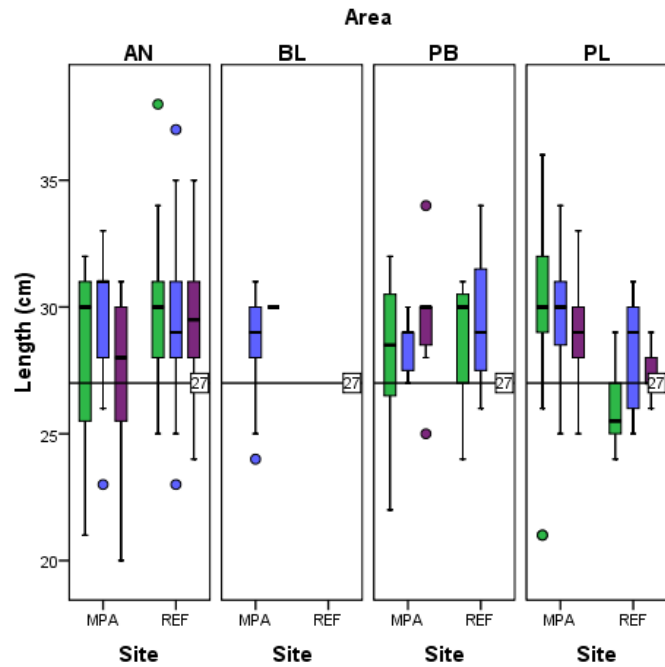

Figure 25. Whisker-plots of the top ten most frequently caught species using hook-and-line gear, with reference to length at 50% maturity for females, by areas, sites, and years. The lower margin of the box represents the 25th percentile lengths, the upper margin the 75th percentile lengths, and the heavy line in the box represents the median length: A) Black rockfish and B) Blue rockfish.

C) China rockfish



D) Copper rockfish

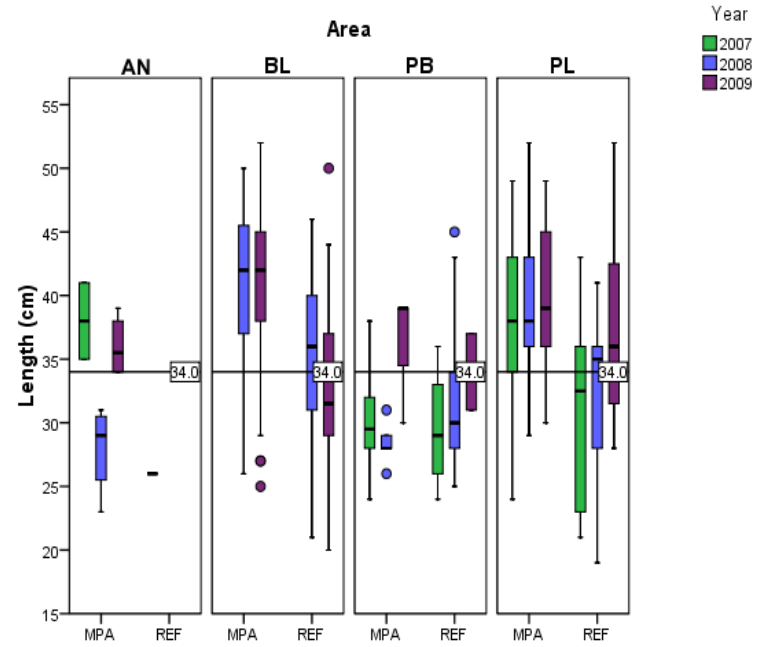
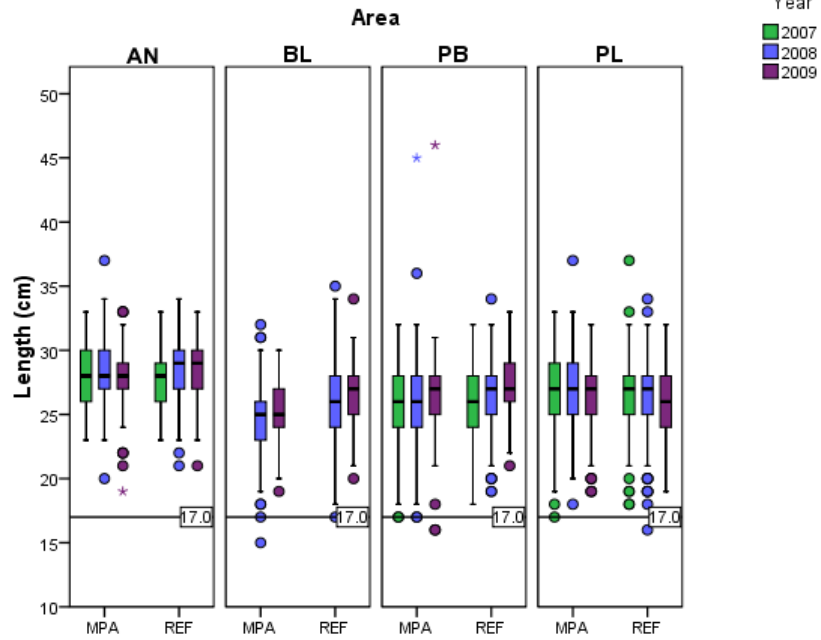

Figure 25 cont. Whisker-plots of the top ten most frequently caught species using hook-and-line gear, with reference to length at 50% maturity for females, by areas, sites, and years. The lower margin of the box represents the 25th percentile lengths, the upper margin the 75th percentile lengths, and the heavy line in the box represents the median length: C) China rockfish and D) Copper rockfish.

E) Gopher rockfish



F) Kelp rockfish

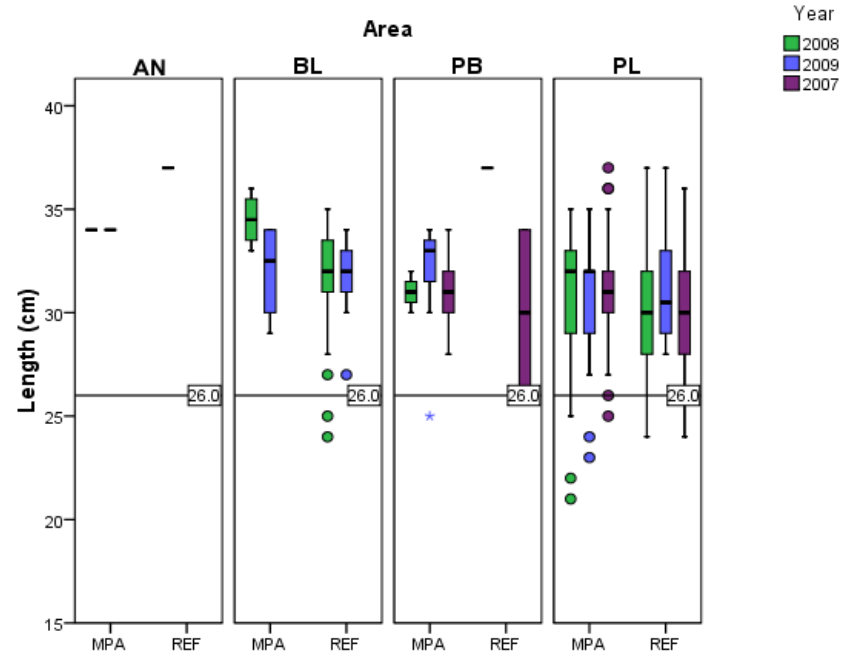
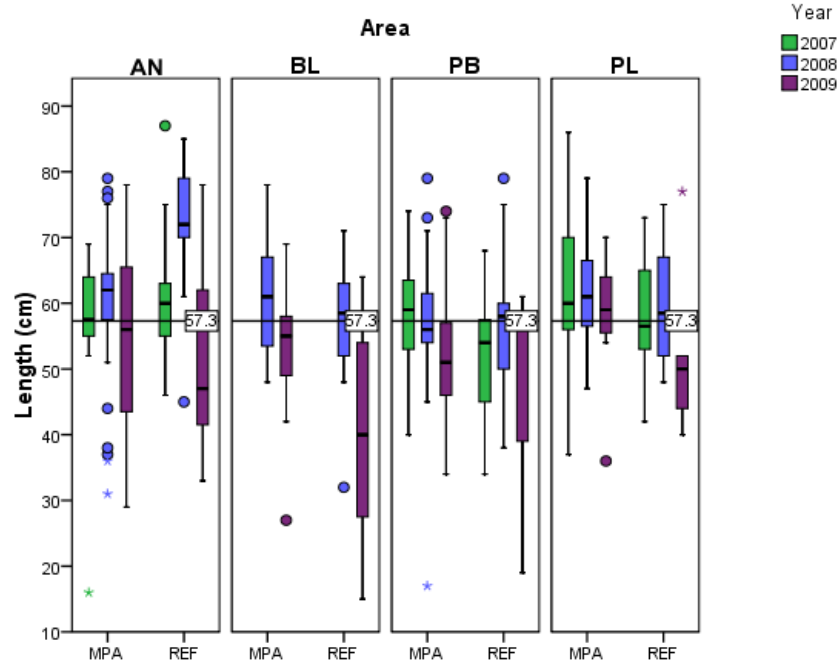

Figure 25 cont. Whisker-plots of the top ten most frequently caught species using hook-and-line gear, with reference to length at 50% maturity for females, by areas, sites, and years. The lower margin of the box represents the 25th percentile lengths, the upper margin the 75th percentile lengths, and the heavy line in the box represents the median length: E) Gopher rockfish and F) Kelp rockfish.

G) Lingcod



H) Olive rockfish

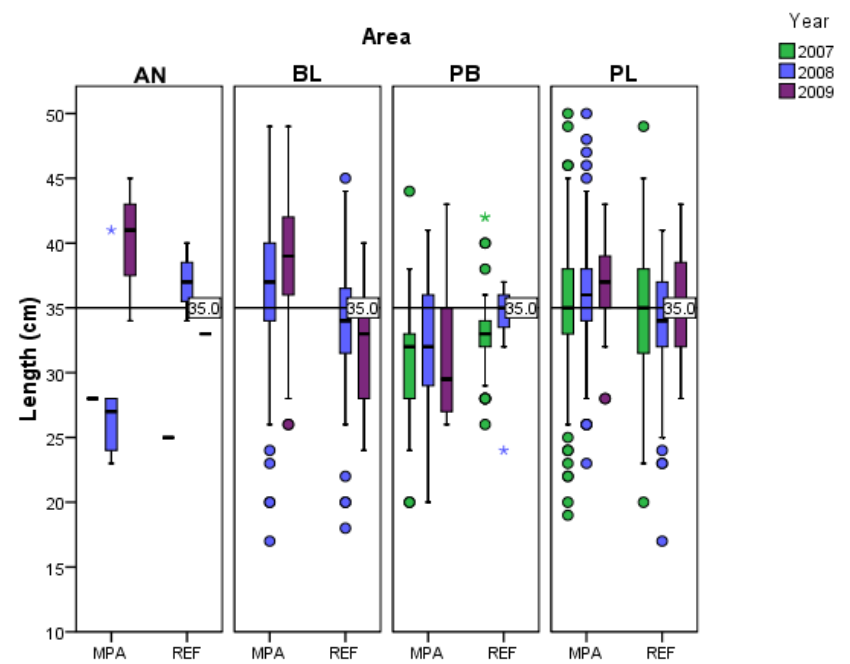
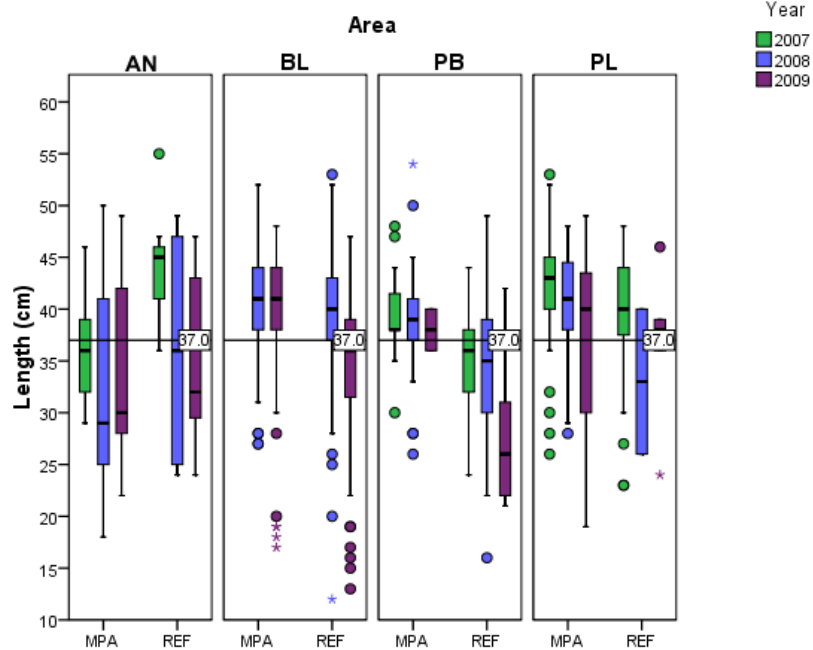

Figure 25 cont. Whisker-plots of the top ten most frequently caught species using hook-and-line gear, with reference to length at 50% maturity for females, by areas, sites, and years. The lower margin of the box represents the 25th percentile lengths, the upper margin the 75th percentile lengths, and the heavy line in the box represents the median length: G) Lingcod and H) Olive rockfish.

H) Vermilion rockfish



I) Yellowtail rockfish

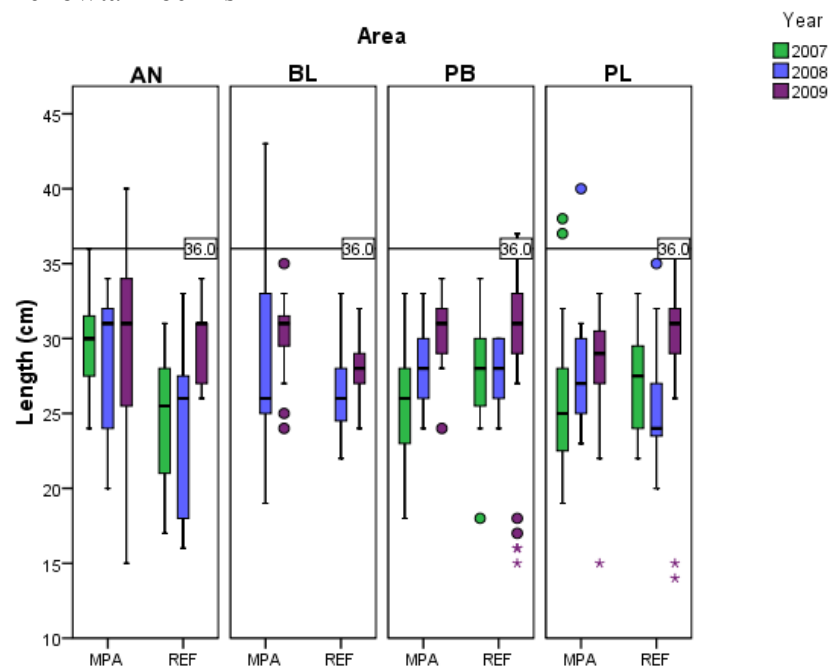

Figure 25 cont. Whisker-plots of the top ten most frequently caught species using hook-and-line gear, with reference to length at 50% maturity for females, by areas, sites, and years. The lower margin of the box represents the 25th percentile lengths, the upper margin the 75th percentile lengths, and the heavy line in the box represents the median length: I) Vermilion rockfish, and J) Yellowtail rockfish.

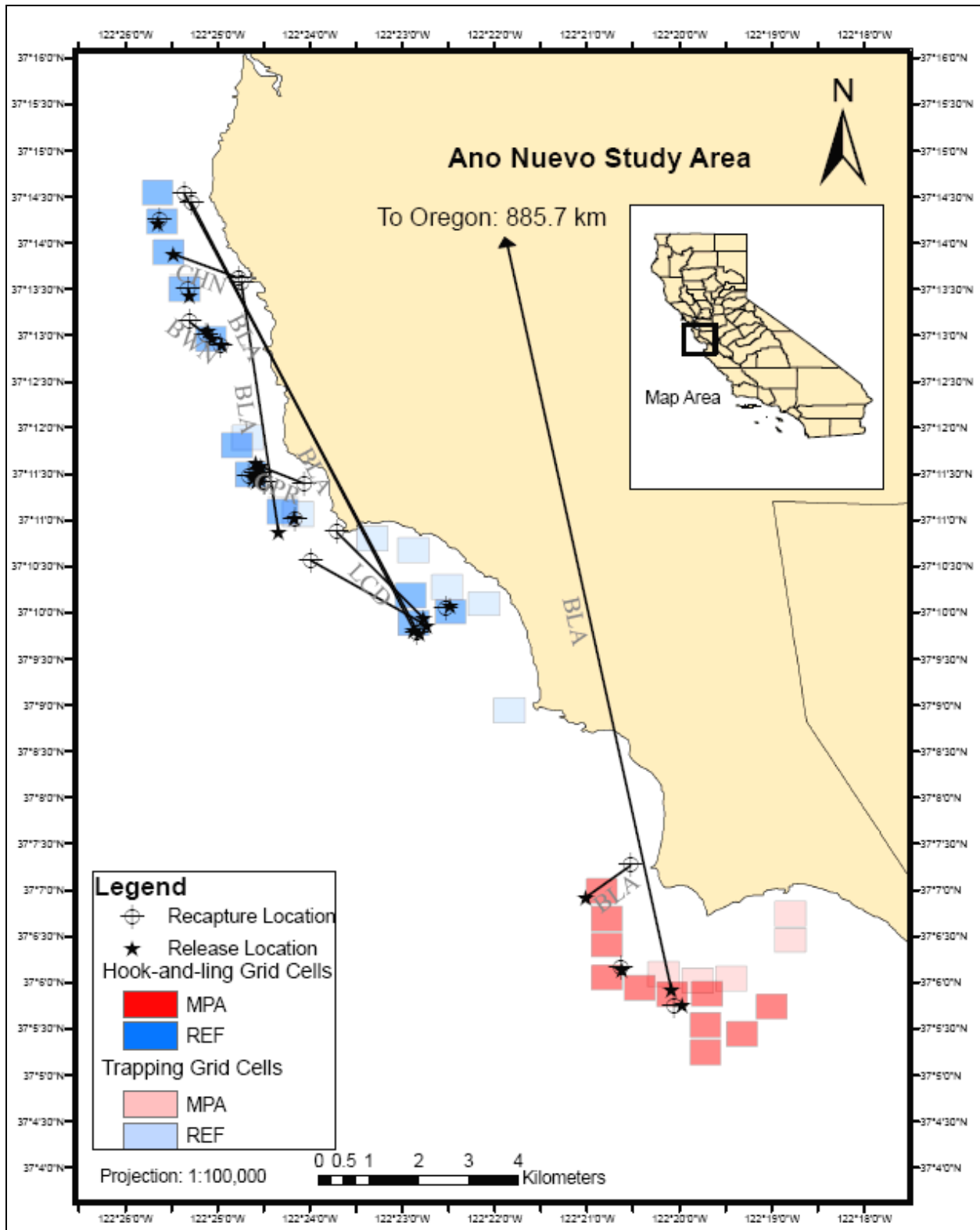

Figure 26. An example of net movements of recaptured fishes that had been released in the Año Nuevo study area, both those caught and released during the hook-and-line and trapping surveys, 2007-2009, with select species codes displayed. Many net movements are small and their species codes were removed to clear map. *Note species coding as follows: BLA=Black rockfish, BWN=Brown rockfish, CHN= China rockfish, GPR=Gopher rockfish, and LCD=Lingcod.